

XL-626 Barcode Scanner

User Manual

V6.6.2

Revision History

Version	Description	Date
V1.0	Initial release.	September 3, 2014

Table of Contents

Revision History	- 3 -
Preface	1
Introduction.....	1
Chapter Description	1
Chapter 1 Getting Started	2
Introduction.....	2
Unpacking	2
Scanner	2
Cable Slot.....	3
Connect Scanner to a Host	4
Use USB Cable.....	5
Use RS-232 Cable	5
Use PS/2 Cable (Hardware Version: V2 or higher)	6
Remove Communication Cable	7
Power on, Power off, Sleep, Reboot.....	7
Maintenance.....	8
Dimensions.....	9
Left View	9
Front View	9
Top View.....	9
Scanning Instructions.....	10
Chapter 2 System Settings	12
Introduction.....	12
Barcode Programming	12
Command Programming.....	12
Read Register	13
Write Register	16
Enable/Disable EEPROM Write.....	19
Write EEPROM	21
Read EEPROM.....	24
Registers	27

Enable/Disable Barcode Programming.....	44
Programming Barcode Data	44
Factory Defaults	45
Scan Mode	46
Manual Mode	46
Continuous Mode.....	47
Sense Mode.....	50
Command Trigger Mode.....	54
Security Level.....	55
Good Read Beep	56
Good Read Beep Frequency.....	57
Good Read Beep Duration	57
Decode Result Notification.....	58
Other Settings	59
Silent Mode	59
Illumination.....	59
Chapter 3 Communication Settings	60
Introduction.....	60
RS-232 Interface	60
Baud Rate	61
Parity Check.....	62
Stop Bit.....	62
Data Bit	63
USB Interface.....	65
USB HID-KBW	65
Standard Keyboard.....	66
Emulate ALT+Keypad.....	66
Function Key Mapping.....	67
ASCII Function Key Mapping Table.....	68
USB Country Keyboard Types	69
Inter-Keystroke Delay	72
Convert Case.....	73
Emulate Numeric Keypad.....	74
USB COM Port Emulation	75

USB DataPipe	76
HID-POS	77
Access the Scanner with Your Program	78
Acquire Scanned Data.....	78
VID/PID.....	78
PS/2 Interface (Hardware Version: V2 or higher)	79
Chapter 4 Data Formatting	80
Introduction.....	80
Prefix Sequence.....	80
Custom Prefix.....	81
Enable/Disable Custom Prefix.....	81
Set Custom Prefix.....	81
AIM ID Prefix	82
CODE ID Prefix	83
Restore All Default Code IDs.....	83
Set Code ID	83
Custom Suffix.....	87
Enable/Disable Custom Suffix	87
Set Custom Suffix	88
Terminating Character Suffix.....	89
Enable/Disable Terminating Character Suffix.....	89
Set Terminating Character Suffix.....	90
Chapter 5 Symbologies	91
Introduction.....	91
Global Settings.....	91
Enable/Disable All Symbologies	91
Code 128.....	92
Restore Factory Defaults	92
Enable/Disable Code 128.....	92
Set Length Range for Code 128.....	93
UCC/EAN-128.....	94
Restore Factory Defaults	94
Enable/Disable UCC/EAN-128.....	94

Set Length Range for UCC/EAN-128.....	95
AIM 128.....	96
Restore Factory Defaults.....	96
Enable/Disable AIM 128.....	96
Set Length Range for AIM 128.....	97
EAN-8.....	98
Restore Factory Defaults.....	98
Enable/Disable EAN-8.....	98
Transmit Check Digit.....	98
Add-On Code.....	99
Add-On Code Required.....	100
EAN-8 Extension.....	100
EAN-13.....	101
Restore Factory Defaults.....	101
Enable/Disable EAN-13.....	101
Transmit Check Digit.....	101
Add-On Code.....	102
Add-On Code Required.....	103
ISSN.....	104
Restore Factory Defaults.....	104
Enable/Disable ISSN.....	104
ISBN.....	105
Restore Factory Defaults.....	105
Enable/Disable ISBN.....	105
Set ISBN Format.....	106
UPC-E.....	107
Restore Factory Defaults.....	107
Enable/Disable UPC-E.....	107
Transmit Check Digit.....	107
Add-On Code.....	108
Add-On Code Required.....	109
Transmit System Character.....	109
UPC-E Extension.....	110
UPC-A.....	111

Restore Factory Defaults	111
Enable/Disable UPC-A	111
Transmit Check Digit.....	112
Transmit Preamble Character.....	112
Add-On Code	113
Add-On Code Required	114
Interleaved 2 of 5	115
Restore Factory Defaults	115
Enable/Disable Interleaved 2 of 5.....	115
Check Digit Verification.....	116
Set Length Range for Interleaved 2 of 5	117
ITF-6.....	118
Restore Factory Defaults	118
Enable/Disable ITF-6.....	118
ITF-14.....	119
Restore Factory Defaults	119
Enable/Disable ITF-14.....	119
Deutsche 14	120
Restore Factory Defaults	120
Enable/Disable Deutsche 14	120
Deutsche 12	121
Restore Factory Defaults	121
Enable/Disable Deutsche 12	121
Matrix 2 of 5 (European Matrix 2 of 5)	122
Restore Factory Defaults	122
Enable/Disable Matrix 2 of 5.....	122
Check Digit Verification.....	123
Set Length Range for Matrix 2 of 5.....	124
Industrial 25.....	125
Restore Factory Defaults	125
Enable/Disable Industrial 25.....	125
Check Digit Verification.....	126
Set Length Range for Industrial 25.....	127
Standard 25.....	128

Restore Factory Defaults	128
Enable/Disable Standard 25	128
Check Digit Verification	129
Set Length Range for Standard 25	130
Code 39	131
Restore Factory Defaults	131
Enable/Disable Code 39	131
Check Digit Verification	132
Transmit Start/Stop Characters	133
Enable/Disable Code 39 Full ASCII	133
Set Length Range for Code 39	134
Codabar	135
Restore Factory Defaults	135
Enable/Disable Codabar	135
Check Digit Verification	136
Start/Stop Characters	137
Set Length Range for Codabar	138
Code 93	139
Restore Factory Defaults	139
Enable/Disable Code 93	139
Check Digit Verification	140
Set Length Range for Code 93	141
Code 11	142
Restore Factory Defaults	142
Enable/Disable Code 11	142
Check Digit Verification	143
Set Length Range for Code 11	144
Plessey	145
Restore Factory Defaults	145
Enable/Disable Plessey	145
Check Digit Verification	146
Set Length Range for Plessey	147
MSI-Plessey	148
Restore Factory Defaults	148

Enable/Disable MSI-Plessey	148
Check Digit Verification.....	149
Set Length Range for MSI-Plessey	150
RSS-14.....	151
Restore Factory Defaults	151
Enable/Disable RSS-14.....	151
Transmit Application Identifier “01”	151
RSS-Limited.....	152
Restore Factory Defaults	152
Enable/Disable RSS-Limited	152
Transmit Application Identifier “01”	152
RSS-Expand	153
Restore Factory Defaults	153
Enable/Disable RSS-Expand.....	153
Appendix	154
Factory Defaults Table	154
AIM ID Table.....	161
Code ID Table.....	163
ASCII Table	164
Digit Barcodes.....	168
Save/Cancel Barcodes	171
F1~F12.....	172

Preface

Introduction

This manual provides detailed instructions for setting up and using the XL-626 hand-held barcode scanner (hereinafter referred to as “**XL-626 scanner**” or “**the scanner**”).

Chapter Description

- ✧ *Chapter 1, Getting Started* : This chapter gives a general description of XL-626 scanner including its technical parameters.
- ✧ *Chapter 2, System Settings* : This chapter introduces two methods to configure the XL-626 scanner: barcode programming and command programming.
- ✧ *Chapter 3, Communication Settings* : This chapter describes how to configure RS-232 and USB parameters.
- ✧ *Chapter 4, Data Formatting* : This chapter describes how to use prefix and suffix to customize scanned data.
- ✧ *Chapter 5, Symbologies* : This chapter lists all compatible symbologies and describes how to configure the relevant parameters.
- ✧ *Appendix* : This chapter offers factory defaults table and a bunch of frequently used programming barcodes.

Chapter 1 Getting Started

Introduction

XL-626 scanner is a 1D barcode scanner with excellent performance. Based on the technology independently developed by XuLong, XL-626 scanner is able to deliver rapid image acquisition and accurate decoding; it can provide customers with best services. XL-626 scanner boasts the ergonomical design that ensures easy and comfortable operation.

An illustrated introduction to the XL-626 scanner is included in this chapter. If you have an XL-626 device at hand, make good use of it to develop a better understanding of this manual. This chapter is written for normal users, maintenance staff and software developers.

Unpacking

Open the package and take out XL-626 scanner and its accessories. Check to make sure everything on the packing list is present and intact. If any contents are damaged or missing, please keep the original package and contact your dealer immediately for after-sale service.

Scanner

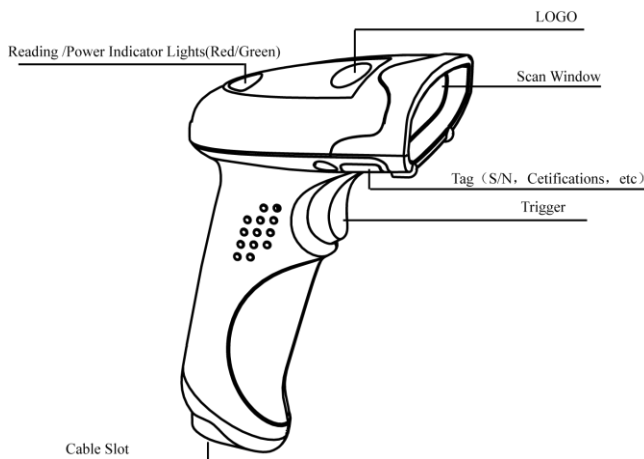

Fig. 1-1

Reading/Power LED:

Red : The device is powered on

Green: Barcode is decoded successfully

Cable Slot

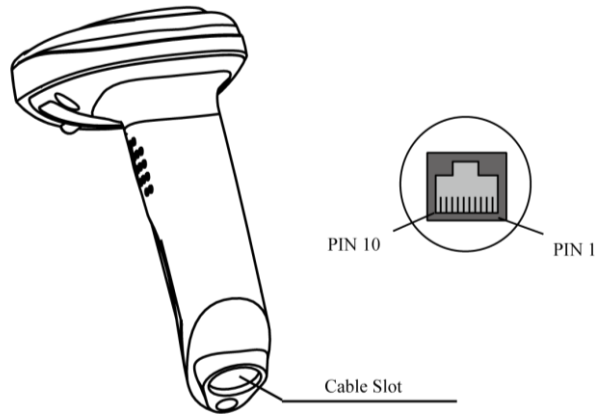

Fig. 1-2

Cable port pinout:

PIN	Definition	Type	Description
1	CLK1	I/O	Keyboard clock signal
2	DATA1	I/O	Keyboard data signal
3	VCC	P	Power+ (DC5V)
4	TXD	O	RS-232 Output
5	RXD	I	RS-232 Input
6	CLK2	I/O	PC clock signal
7	DATA2	I/O	PC keyboard signal
8	GND	P	Ground
9	D-	I/O	USB signal
10	D+	I/O	

Connect XI-626 to a Host

XL-626 scanner must be connected to a host device in actual application, such as PC, POS or any intelligent terminal with USB or RS-232 or PS/2 (hardware version: V2 or higher) interface, using a communication cable (USB or RS-232 or PS/2 cable).

✧ USB

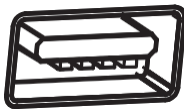

USB port on the host

✧ RS-232



RS-232 port on the host

✧ PS/2



PS/2 port on the host

Note: Please check the port on the host and purchase the right cable.

Use USB Cable

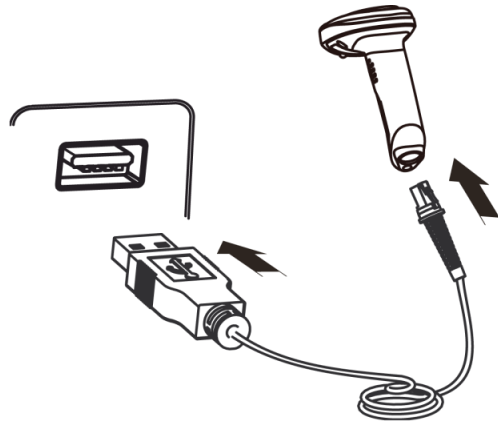

Fig. 1-3

Connect XL-626 scanner to a Host through a USB cable with RJ45 and USB connectors:

1. Plug the RJ45 connector into the cable slot (see Fig.1-1) on the scanner.
2. Plug the USB connector into the USB port on the Host.

Use RS-232 Cable

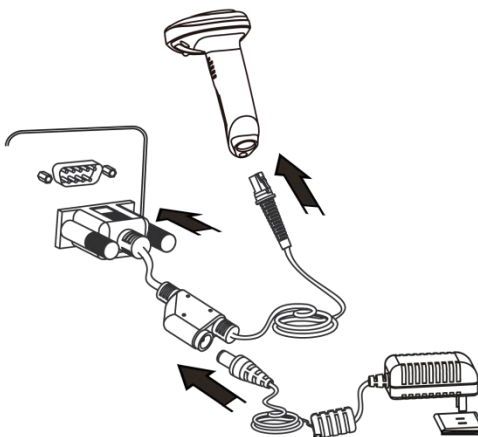

Fig. 1-4

Connect XL-626 scanner to a Host through an RS-232 cable with RJ45/RS-232 connectors and a power jack:

1. Plug the RJ45 connector into the cable slot (see Fig.1-1) on the scanner.
 2. Plug the RS-232 connector into the RS-232 port on the Host.
 3. Plug the power adapter into the power jack on the RS-232 cable.
-

Use PS/2 Cable (Hardware Version: V2 or higher)

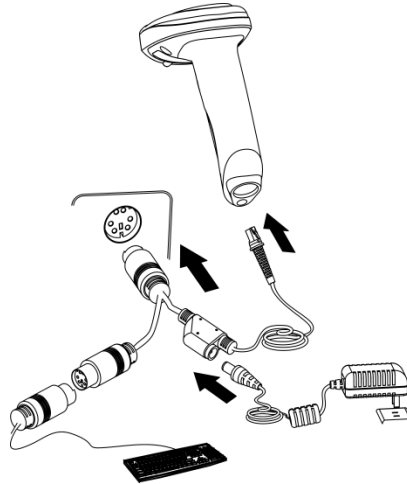

Fig. 1-5

Connect XL-626 scanner to a Host through a PS/2 cable with RJ45 and PS/2 connectors and a power jack:

1. Plug the RJ45 connector into the data slot (see Fig.1-1) on the scanner.
2. Plug the PS/2 connector into the PS/2 port on the Host.
3. When required, plug the power adapter into the power jack on the PS/2 cable.
4. When required, connect the PS/2 cable to a keyboard via its PS/2 port.

Remove Communication Cable

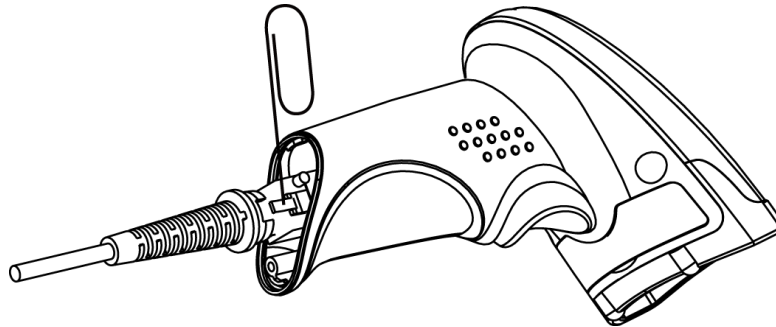

Fig. 1-6

Get an appropriate needle or a straightened paper clip and then follow the steps below:

1. Disconnect the power adapter from mains and the scanner if there is one.
2. Insert the needle into the disassemble hole (Fig. 1-6).
3. Pull out the cable slowly from the scanner while pressing the needle in. Then remove the needle.
4. Disconnect the cable from the Host.

Power on, Power off, Sleep, Reboot

Power on the scanner

Connect the scanner to a host device. Then the scanner will be turned on and automatically go into sleep mode.

Power off the scanner

There are three ways to turn off the scanner:

- ✧ Remove the cable from the scanner.
- ✧ Remove the cable from the host device.
- ✧ Disconnect the power adapter from mains or the scanner.

Enter the sleep mode

If no operation is performed on the scanner for some time, the scanner will automatically enter the sleep state.

Reboot the scanner

If the scanner stops responding to input or runs abnormally, disconnect the scanner from the host device and then reconnect it.

Maintenance

- ✧ The scan window should be kept clean.
- ✧ Do not scratch the scan window of the device.
- ✧ Use soft brush to remove the stain from the scan window.
- ✧ Use the soft cloth to clean the window, such as eyeglass cleaning cloth.
- ✧ Do not spray any liquid on the scan window.
- ✧ Clean other parts of the device with water only.

Note: The warranty **DOES NOT** cover damages caused by inappropriate care and maintenance.

Dimensions

Left View

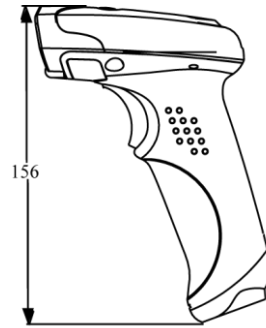

Unit: mm

Fig. 1-7

Front View

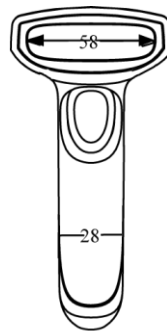

Unit: mm

Fig. 1-8

Top View

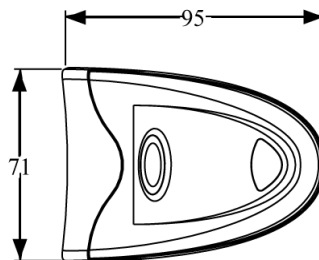

Unit: mm

Fig. 1-9

Scanning Instructions

When the XL-626 scanner is in the Manual mode, you can follow the steps below to scan a barcode:

1. Hold down the trigger. Then the scanner will project a red aiming beam.
2. Aim the red beam across the center of barcode, as shown in Fig.1-10.
3. Release the trigger when the red beam goes off. For a successful read, the scanner will beep and send the decoded data to the Host.

Note: For barcodes of the same batch, the scanner keeps a very high success ratio in certain distance which is regarded as the optimal scanning distance.

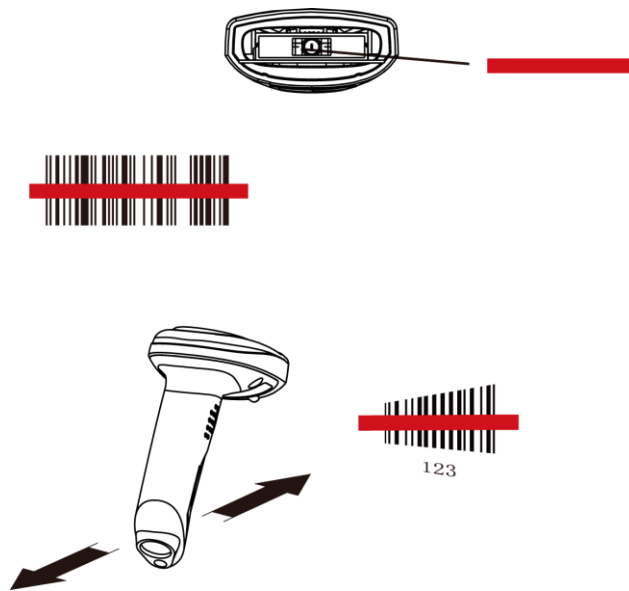

Fig. 1-10

Scan Angle

The scanner is designed to function within a certain range of scan angles. Any unreasonable deviation may cause decoding failure.

Scan angles of the scanner:

- ◇ Pitch : $\pm 60^\circ$, 0° Roll and 0° Skew (Fig. 1-11)
- ◇ Roll : $\pm 30^\circ$, 0° Pitch and 0° Skew (Fig. 1-12)
- ◇ Skew: $\pm 60^\circ$, 0° Roll and 0° Pitch (Fig. 1-13)

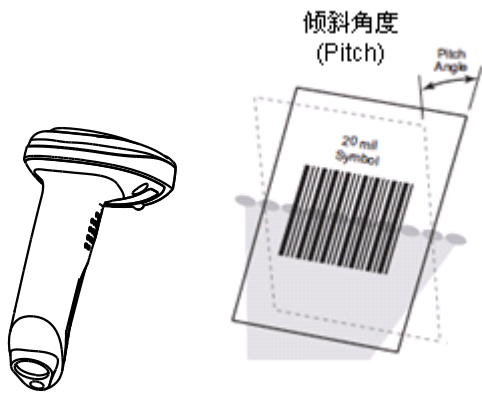

Fig. 1-11

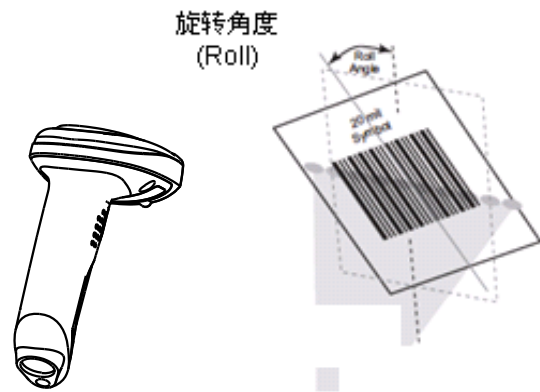

Fig. 1-12

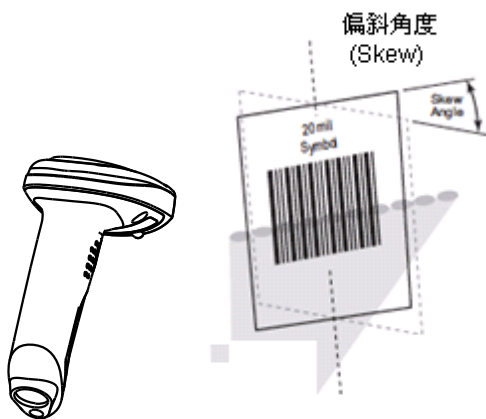

Fig. 1-13



W010F01

** Enter Setup

Chapter 2 System Settings

Introduction

There are two ways to configure the scanner: barcode programming and command programming.

Barcode Programming

The scanner can be configured by scanning programming barcodes. All user programmable features/options are described along with their programming barcodes/commands in the following sections.

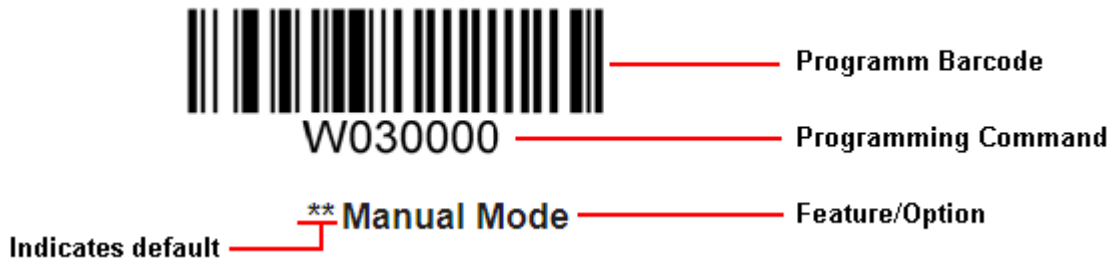

Command Programming

Besides the barcode programming method, the scanner can also be configured by serial commands sent from the host device. Note that communication parameters on the scanner and the host must match so that two devices can communicate with each other. The default settings of the scanner are 9600bps, no parity check, 8 data bits, 1 stop bit, and no flow control. The scanner uses 8-bit registers.



W010F00

Exit Setup



W010F01

** Enter Setup

Read Register

The read register command is used to read the contents of 1 to 256 contiguous registers in the scanner.

Syntax: {Prefix1} {Types} {Lens} {Address} {Datas} {FCS}

Prefix1 : 0x7E 0x00 (2 bytes)

Types : 0x07 (1 byte)

Lens : 0x01 (1 byte).

Address: 0x0000~0xFFFF (2 bytes), starting register address.

Datas : 0x00~0xFF (1 byte), number of registers to be read. When Datas=0x00, 256 contiguous registers are to be read.

FCS : CRC-CCITT checksum (2 bytes)
Computation sequence: Types+ Lens+Address+Datas;
polynomial: $X^{16}+X^{12}+X^5+1$ (0x1021), initial value: 0x0000.

The following C language program is provided for reference.

```
unsigned int crc_cal_by_bit(unsigned char* ptr, unsigned int len)
{
    unsigned int crc = 0;
    while(len-- != 0)
    {
        for(unsigned char i = 0x80; i != 0; i /= 2)
        {
            crc *= 2;
            if((crc&0x10000) != 0)
                crc ^= 0x11021;
            if((*ptr&i) != 0)
                crc ^= 0x1021;
        }
        ptr++;
    }
    return crc;
}
```



W010F00

Exit Setup



W010F01

** Enter Setup

Reply: {Prefix2} {Types} {Lens} {Datas} {FCS}

1) Success message:

Prefix2 : 0x02 0x00

Types : 0x00 (success)

Lens : Byte count of Datas returned. If Lens=0x00, that means values of 256 contiguous registers are returned.

Datas : 0x00~0xFF, data that are returned.

FCS : CRC-CCITT checksum.

2) FCS error message:

Prefix2 : 0x02 0x00

Types : 0x01 (incorrect FCS)

Lens : 0x01

Datas : 0x00

FCS : 0x04 0x01 (CRC-CCITT checksum)

3) Invalid command message (Command starting with 0x7e 0x00 is shorter than the required length or of wrong type):

Prefix2 : 0x02 0x00

Types : 0x03 (invalid command)

Lens : 0x01

Datas : 0x00

FCS : 0x6A 0x61 (CRC-CCITT checksum)



W010F00

Exit Setup



W010F01

** Enter Setup

Example:

Read the contents (0x35, 0x36, 0x37) of 3 contiguous registers starting from register 0x0005.

1) Read operation succeeds:

Command sent: 0x7e 0x00 0x07 0x01 0x00 0x05 0x03 0xde 0xf6

Message received: 0x02 0x00 0x00 0x03 0x35 0x36 0x37 0x2a 0xba

2) Incorrect FCS:

Command sent: 0x7e 0x00 0x07 0x01 0x00 0x05 0x03 0x33 0x34

Message received: 0x02 0x00 0x01 0x01 0x00 0x04 0x01

3) Invalid command:

Command sent: 0x7e 0x00 0x07 0x01 0x00 0x05 0x03 0x33

Message received: 0x02 0x00 0x03 0x01 0x00 0x6A 0x61



W010F00

Exit Setup



W010F01

** Enter Setup

Write Register

The write register command is used to write contiguous registers (1 to 256 registers) in the scanner.

Syntax: {Prefix1} {Types} {Lens} {Address} {Datas} {FCS}

Prefix1 : 0x7E 0x00 (2 bytes)

Types : 0x08 (1 byte)

Lens : 0x00~0xFF (1 byte), byte count, i.e. number of registers written. When Lens=0x00, 256 contiguous registers are to be written.

Address : 0x0000~0xFFFF (2 bytes), starting register address.

Datas : 0x00~0xFF (1~256 bytes), data to be written into the register(s)

FCS : CRC-CCITT checksum (2 bytes).

Computation sequence: Types+ Lens+Address+Datas;

polynomial: $X^{16}+X^{12}+X^5+1$ (0x1021), initial value: 0x0000.

The following C language program is provided for reference.

```
unsigned int crc_cal_by_bit(unsigned char* ptr, unsigned int len)
{
    unsigned int crc = 0;
    while(len-- != 0)
    {
        for(unsigned char i = 0x80; i != 0; i /= 2)
        {
            crc *= 2;
            if((crc&0x10000) != 0)
                crc ^= 0x11021;
            if((*ptr&i) != 0)
                crc ^= 0x1021;
        }
        ptr++;
    }
    return crc;
}
```



W010F00

Exit Setup



W010F01

** Enter Setup

Reply: {Prefix2} {Types} {Lens} {Datas} {FCS}

1) Success message:

Prefix2 : 0x02 0x00

Types : 0x00 (success)

Lens : 0x01

Datas : 0x00

FCS : 0x33 0x31 (CRC-CCITT checksum)

2) FCS error message:

Prefix2 : 0x02 0x00

Types : 0x01 (incorrect FCS)

Lens : 0x01

Datas : 0x00

FCS : 0x04 0x01 (CRC-CCITT checksum)

3) Invalid command message (Command starting with 0x7e 0x00 is shorter than the required length or of wrong type):

Prefix2 : 0x02 0x00

Types : 0x03 (invalid command)

Lens : 0x01

Datas : 0x00

FCS : 0x6A 0x61 (CRC-CCITT checksum)



W010F00

Exit Setup



W010F01

** Enter Setup

Example:

Write 0x31, 0x32, 0x33, 0x34 into 4 contiguous registers starting from register 0x000a.

1) Write operation succeeds:

Command sent: 0x7e 0x00 0x08 0x04 0x00 0x26 0x31 0x32 0x33 0x34 0xcd 0xa4

Message received: 0x02 0x00 0x00 0x01 0x00 0x33 0x31

2) Incorrect FCS:

Command sent: 0x7e 0x00 0x08 0x04 0x00 0x26 0x31 0x32 0x33 0x34 0x33 0x34

Message received: 0x02 0x00 0x01 0x01 0x00 0x04 0x01

3) Invalid command:

Command sent: 0x7e 0x00 0x08 0x04 0x00 0x26 0x31 0x32 0x33 0x34 0x33

Message received: 0x02 0x00 0x03 0x01 0x00 0x6A 0x61



W010F00

Exit Setup



W010F01

** Enter Setup

Enable/Disable EEPROM Write

By default, EEPROM write is disabled after the device is powered up. You need to enable it before a write operation and recommendedly disable it afterwards to prevent miswriting.

Syntax: {Prefix1} {Types} {Lens} {Address} {Datas} {FCS}

Prefix1 : 0x7E 0x00

Types : 0x03 (EEPROM write enable)/ 0x00 (EEPROM write disable)

Lens : Byte count of Datas, 0x01 recommended.

Address : No specific significance.

Datas : No specific significance.

FCS : CRC-CCITT checksum (2 bytes).

Computation sequence: Types+ Lens+Address+Datas;

polynomial: $X^{16}+X^{12}+X^5+1$ (0x1021), initial value: 0x0000.

The following C language program is provided for reference.

```
unsigned int crc_cal_by_bit(unsigned char* ptr, unsigned int len)
{
    unsigned int crc = 0;
    while(len-- != 0)
    {
        for(unsigned char i = 0x80; i != 0; i /= 2)
        {
            crc *= 2;
            if((crc&0x10000) != 0)
                crc ^= 0x11021;
            if((*ptr&i) != 0)
                crc ^= 0x1021;
        }
        ptr++;
    }
    return crc;
}
```



W010F00

Exit Setup



W010F01

** Enter Setup

Reply: {Prefix2} {Types} {Lens} {Datas} {FCS}

1) Success message:

Prefix2 : 0x02 0x00

Types : 0x00 (success)

Lens : 0x01

Datas : 0x00

FCS : 0x33 0x31 (CRC-CCITT checksum)

2) FCS error message:

Prefix2 : 0x02 0x00

Types : 0x01 (incorrect FCS)

Lens : 0x01

Datas : 0x00

FCS : 0x04 0x01 (CRC-CCITT checksum)

3) Invalid command message (Command starting with 0x7e 0x00 is shorter than the required length or of wrong type):

Prefix2 : 0x02 0x00

Types : 0x03 (invalid command)

Lens : 0x01

Datas : 0x00

FCS : 0x6A 0x61 (CRC-CCITT checksum)



W010F00

Exit Setup



W010F01

** Enter Setup

Write EEPROM

The scanner has 512 bytes of EEPROM. The EEPROM write command is used to write data to up to 256 addresses. You need to enable EEPROM write before a write operation and recommendedly disable it afterwards to prevent miswriting. Note that writing without enabling it first will not return any error message. So it is recommended to implement EEPROM read operation after every write for verification.

Syntax: {Prefix1} {Types} {Lens} {Address} {Datas} {FCS}

Prefix1 : 0x7E 0x00

Types : 0x04

Lens : 0x00~0xFF, byte count of Datas. When Lens=0x00, 256 bytes are to be written.

Address : 0x0000~0xFFFF, starting address to write data to.

Datas : 0x00~0xFF, data to be written into the EEPROM

FCS : CRC-CCITT checksum (2 bytes).

Computation sequence: Types+ Lens+Address+Datas;

polynomial: $X^{16}+X^{12}+X^5+1$ (0x1021), initial value: 0x0000.

The following C language program is provided for reference.

```
unsigned int crc_cal_by_bit(unsigned char* ptr, unsigned int len)
{
    unsigned int crc = 0;
    while(len-- != 0)
    {
        for(unsigned char i = 0x80; i != 0; i /= 2)
        {
            crc *= 2;
            if((crc&0x10000) != 0)
                crc ^= 0x11021;
            if((*ptr&i) != 0)
                crc ^= 0x1021;
        }
        ptr++;
    }
    return crc;
}
```



W010F00

Exit Setup



W010F01

** Enter Setup

Reply: {Prefix2} {Types} {Lens} {Datas} {FCS}

1) Success message:

Prefix2 : 0x02 0x00
Types : 0x00 (success)
Lens : 0x01
Datas : 0x00
FCS : 0x33 0x31 (CRC-CCITT checksum)

2) FCS error message:

Prefix2 : 0x02 0x00
Types : 0x01 (incorrect FCS)
Lens : 0x01
Datas : 0x00
FCS : 0x04 0x01 (CRC-CCITT checksum)

3) EERPOM not responding message:

Prefix2 : 0x02 0x00
Types : 0x02 (EEPROM not responding)
Lens : 0x01
Datas : 0x00
FCS : 0x5d 0x51 (CRC-CCITT checksum)

4) Invalid command message (Command starting with 0x7e 0x00 is shorter than the required length or of wrong type):

Prefix2 : 0x02 0x00
Types : 0x03 (invalid command)
Lens : 0x01
Datas : 0x00
FCS : 0x6A 0x61 (CRC-CCITT checksum)



W010F00

Exit Setup



W010F01

** Enter Setup

Example:

Write 0x51, 0x52, 0x53, 0x54 into 4 contiguous addresses starting from address 0x0000.

1) Write operation succeeds:

Command sent: 0x7e 0x00 0x04 0x04 0x00 0x00 0x51 0x52 0x53 0x54 0xbc 0x17

Message received: 0x02 0x00 0x00 0x01 0x00 0x33 0x31

2) Incorrect FCS:

Command sent: 0x7e 0x00 0x04 0x03 0x00 0x00 0x51 0x52 0x53 0x54 0x33 0x34

Message received: 0x02 0x00 0x01 0x01 0x00 0x04 0x01



W010F00

Exit Setup



W010F01

** Enter Setup

Read EEPROM

The scanner has 512 bytes of EEPROM. The EEPROM read command is used to read the contents from 1 to 256 contiguous addresses of the EEPROM.

Syntax: {Prefix1} {Types} {Lens} {Address} {Datas} {FCS}

Prefix1 : 0x7E 0x00

Types : 0x05

Lens : 0x01

Address: 0x0000~0xFFFF (2 bytes), starting EEPROM address to read.

Datas : 0x00~0xFF, number of EEPROM addresses to be read. When Datas=0x00, 256 contiguous addresses are to be read.

FCS : CRC-CCITT checksum (2 bytes)
Computation sequence: Types+ Lens+Address+Datas;
polynomial: $X^{16}+X^{12}+X^5+1(0x1021)$, initial value: 0x0000.

The following C language program is provided for reference.

```
unsigned int crc_cal_by_bit(unsigned char* ptr, unsigned int len)
{
    unsigned int crc = 0;
    while(len-- != 0)
    {
        for(unsigned char i = 0x80; i != 0; i /= 2)
        {
            crc *= 2;
            if((crc&0x10000) != 0)
                crc ^= 0x11021;
            if((*ptr&i) != 0)
                crc ^= 0x1021;
        }
        ptr++;
    }
    return crc;
}
```



W010F00

Exit Setup



W010F01

** Enter Setup

Reply: {Prefix2} {Types} {Lens} {Datas} {FCS}

1) Success message:

Prefix2 : 0x02 0x00

Types : 0x00 (success)

Lens : Byte count of Datas returned.

Datas : 0x00~0xFF, data that are returned.

FCS : CRC-CCITT checksum.

2) FCS error message:

Prefix2 : 0x02 0x00

Types : 0x01 (incorrect FCS)

Lens : 0x01

Datas : 0x00

FCS : 0x04 0x01 (CRC-CCITT checksum)

3) EERPOM not responding message:

Prefix2 : 0x02 0x00

Types : 0x02 (EEPROM not responding)

Lens : 0x01

Datas : 0x00

FCS : 0x5d 0x51 (CRC-CCITT checksum)

4) Invalid command message (Command starting with 0x7e 0x00 is shorter than the required length or of wrong type):

Prefix2 : 0x02 0x00

Types : 0x03 (invalid command)

Lens : 0x01

Datas : 0x00

FCS : 0x6A 0x61 (CRC-CCITT checksum)



W010F00

Exit Setup



W010F01

** Enter Setup

Example:

Read the contents (0x35 0x36 0x37) of 3 contiguous EEPROM addresses starting from address 0x0005.

1) Read operation succeeds:

Command sent: 0x7e 0x00 0x05 0x01 0x00 0x05 0x03 0x9a 0x75

Message received: 0x02 0x00 0x00 0x03 0x35 0x36 0x37 0x2a 0xba

2) Incorrect FCS:

Command sent: 0x7e 0x00 0x05 0x01 0x00 0x05 0x03 0x33 0x34

Message received: 0x02 0x00 0x01 0x01 0x00 0x04 0x01



W010F00

Exit Setup



W010F01

** Enter Setup

Registers

Register	0x0000	
Bit	Feature	
Bit 7	Reserved	
Bit 6	1: Silent Mode Off	0: Silent Mode On
Bit 5-4	Reserved	
Bit 3-2	Illumination: 00: Off 01: On When Scanning 10/11: Always On	
Bit 1-0	Scan Mode: 00: Manual Mode 01: Command Trigger Mode 10: Continuous Mode 11: Sense Mode	
Register	0x0003	
Bit	Feature	
Bit 7-0	Sensitivity 0x00~0xFF: 0-255 levels. The smaller the value, the higher the sensitivity.	
Register	0x0004	
Bit	Feature	
Bit 7-0	Image Stabilization Timeout 0x00-0xFF: 0.0-25.5s	
Register	0x0005	
Bit	Feature	
Bit 7-0	Timeout between Decodes 0x00-0xFF: 0.0-25.5s	
Register	0x0006	
Bit	Feature	
Bit 7-0	Decode Session Timeout 0x00: Infinite time; 0x01-0xFF: 1-255s	
Register	0x0007	
Bit	Feature	
Bit 7-0	Timeout between Decodes (Same Barcode) 0x00: Infinite time; 0x01-0xFF: 0.1-25.5s	



W010F00

Exit Setup



W010F01

** Enter Setup

Register 0x0009	
Bit	Feature
Bit 7-5	Reserved
Bit 4	0: Serial Communication
Bit 3-2	Reserved
Bit 1-0	00: USB DataPipe 01: USB HID-KBW 10: USB COM Port Emulation 11: USB HID-POS
Register 0x000A	
Bit	Feature
Bit 7-5	Reserved
Bit 4	0: Allow Rereading Same Barcode 1: Disallow Rereading Same Barcode
Bit 3-2	Reserved
Bit 1-0	Security Level 00-03: 0-3 level. The higher the value, the lower the error rate and efficiency.
Register 0x000F	
Bit	Feature
Bit 7-3	Reserved
Bit 2-1	00: Do Not Transmit Programming Barcode Data 11: Transmit Programming Barcode Data
Bit 0	0: Exit Setup 1: Enter Setup
Register 0x0010	
Bit	Feature
Bit 7-0	Good Read Beep Frequency 0xDA: Low 0x4B: Medium 0x25: High
Register 0x0011	
Bit	Feature
Bit 7-0	Good Read Beep Duration 0x1F: 40ms 0x3E: 80ms 0x5D: 120ms
Register 0x0012	
Bit	Feature
Bit 7-3	Reserved
Bit 2	1: Good Read Beep On 0: Good Read Beep Off
Bit 1-0	Reserved



W010F00

Exit Setup



W010F01

** Enter Setup

Register	0x0019		
Bit	Feature		
Bit 7-0	USB Country Keyboard Types		
	00: U.S.	01: Belgium	02: Brazil
	03: Canada	04: Czech	05: Denmark
	06: Finland	07: France	08: Austria
	09: Greece	0A: Hungary	0B: Israel
	0C: Italy	0D: Latin America	0E: Netherland
	0F: Norway	10: Poland	11: Portugal
	12: Romania	13: Russia	15: Slovakia
	16: Spain	17: Sweden	18: Switzerland
	19: Turkey1	1A: Turkey2	1B: UK
	1C: Japan		
	Register	0x001A	
Bit	Feature		
Bit 7-6	Inter-keystroke delay		
	00: No delay	01: Short delay (5ms)	
	10: Medium delay (10ms)	11: Long delay (15ms)	
Bit 5-3	Convert case		
	000: No Case Conversion	001: Invert Upper and Lower Case Characters	
	100/101: Convert All to Upper Case	110/111: Convert All to Lower Case	
Bit 2	1: Emulate Numeric Keypad	0: Do Not Emulate Numeric Keypad	
Bit 1-0	00: Standard Keyboard	01: Function Key Mapping	10/11: Emulate ALT+Keypad



W010F00

Exit Setup



W010F01

** Enter Setup

Register	0x0029	
Bit	Feature	
Bit 7-4	Reserved	
Bit 3	1: 8 Data Bits	0: 7 Data Bits
Bit 2-1	Parity Check 00/01: None	10: Odd 11: Even
Bit 0	1: 2 Stop Bits	0: 1 Stop Bit
Register	0x002B, 0x2A	
Bit	Feature	
Bit 15-13	Reserved	
Bit 12-0	0x09C4: Baud Rate 1200 0x04E2: Baud Rate 2400 0x0271: Baud Rate 4800 0x0139: Baud Rate 9600 0x00D0: Baud Rate 14400 0x009C: Baud Rate 19200 0x004E: Baud Rate 38400 0x0034: Baud Rate 57600 0x001A: Baud Rate 115200	
Register	0x0031	
Bit	Feature	
Bit 7-6	Reserved	
Bit 5	1: Enable Decode Result Notification	0: Disable Decode Result Notification
Bit 4	1: Enable Terminating Character Suffix	0: Disable Terminating Character Suffix
Bit 3	1: Enable Custom Suffix	0: Disable Custom Suffix
Bit 2	1: Enable Custom Prefix	0: Disable Custom Prefix
Bit 1	1: Enable CODE ID Prefix	0: Disable CODE ID Prefix
Bit 0	Prefix Sequence 1: Custom+Code ID+ AIM ID	0: Code ID+Custom+AIM ID



W010F00

Exit Setup



W010F01

** Enter Setup

Register	<i>0x0037-0x33</i>		
Bit	Feature		
Bit 39-0	Set Custom Prefix		
Register	<i>0x0042-0x3E</i>		
Bit	Feature		
Bit 39-0	Set Custom Suffix		
Register	<i>0x004D-0x49</i>		
Bit	Feature		
Bit 39-0	Set Terminating Character Suffix		
Register	<i>0x0061</i>		
Bit	Feature		
Bit 7-1	Reserved		
Bit 0	1: Enable Code 128	0: Disable Code 128	
Register	<i>0x0062</i>		
Bit	Feature		
Bit 7-2	Reserved		
Bit 1-0	00: Disable UCC/EAN 128	01: Decode as Code 128	10/11: Enable UCC/EAN 128
Register	<i>0x0063</i>		
Bit	Feature		
Bit 7-2	Reserved		
Bit 1-0	00: Disable AIM 128	01: Decode as Code 128	10/11: Enable AIM 128
Register	<i>0x0065</i>		
Bit	Feature		
Bit 7-6	EAN-8 Extension 00: Disable EAN-8 Zero Extend 01: Enable EAN-8 Zero Extend 10/11: Convert EAN-8 to EAN-13		
Bit 5	1: Enable EAN-8 5-digit Add-on Code	0: Disable EAN-8 5-digit Add-on Code	
Bit 4	1: Enable EAN-8 2-digit Add-on Code	0: Disable EAN-8 2-digit Add-on Code	
Bit 3	1: EAN-8 Add-on Code Required	0: EAN-8 Add-on Code Not Required	
Bit 2	1: Transmit EAN-8 Check Digit	0: Do Not Transmit EAN-8 Check Digit	
Bit 1	Reserved		
Bit 0	1: Enable EAN-8	0: Disable EAN-8	



W010F00

Exit Setup



W010F01

** Enter Setup

Register	0x006A	
Bit	Feature	
Bit 7-6	Reserved	
Bit 5-4	UPC-E System Character 01: Do not transmit system character 10/11: Transmit system character	
Bit 3-2	Reserved	
Bit 1-0	UPC-A Preamble Character 00: No Preamble 01: System Character 10/11: System Character & Country Code	
Register	0x006B	
Bit	Feature	
Bit 7	Reserved	
Bit 6	1: Enable UPC-A 5-digit Add-on Code	0: Disable UPC-A 5-digit Add-on Code
Bit 5	1: Enable UPC-A 2-digit Add-on Code	0: Disable UPC-A 2-digit Add-on Code
Bit 4	1: UPC-A Add-on Code Required	0: UPC-A Add-on Code Not Required
Bit 3	1: Transmit UPC-A Check Digit	0: Do Not Transmit UPC-A Check Digit
Bit 2	Reserved	
Bit 1-0	00: Disable UPC-A 01: Decode as EAN-13 10/11: Enable UPC-A	
Register	0x006C	
Bit	Feature	
Bit 7-4	Reserved	
Bit 3	1: Transmit Interleaved 2 of 5 Check Digit	0: Do Not Transmit Interleaved 2 of 5 Check Digit
Bit 2	1: Enable Interleaved 2 of 5 Check Digit	0: Disable Interleaved 2 of 5 Check Digit
Bit 1	Reserved	
Bit 0	1: Enable Interleaved 2 of 5	0: Disable Interleaved 2 of 5
Register	0x006D	
Bit	Feature	
Bit 7-4	Reserved	
Bit 3	1: Transmit ITF-6 Check Digit	0: Do Not Transmit ITF-6 Check Digit
Bit 2	Reserved	
Bit 1-0	00: Disable ITF-6 01: Decode as Interleaved 2 of 5 10/11: Enable ITF-6	



W010F00

Exit Setup



W010F01

** Enter Setup

Register	0x006E	
Bit	Feature	
Bit 7-4	Reserved	
Bit 3	1: Transmit ITF-14 Check Digit	0: Do Not Transmit ITF-14 Check Digit
Bit 2	Reserved	
Bit 1-0	00: Disable ITF-14 01: Decode as Interleaved 2 of 5 10/11: Enable ITF-14	
Register	0x006F	
Bit	Feature	
Bit 7-4	Reserved	
Bit 3	1: Transmit Deutsche 14 Check Digit	0: Do Not Transmit Deutsche 14 Check Digit
Bit 2	Reserved	
Bit 1-0	00: Disable Deutsche 14 01: Decode as Interleaved 2 of 5 10/11: Enable Deutsche 14	
Register	0x0070	
Bit	Feature	
Bit 7-4	Reserved	
Bit 3	1: Transmit Deutsche 12 Check Digit	0: Do Not Transmit Deutsche 12 Check Digit
Bit 2	Reserved	
Bit 1-0	00: Disable Deutsche 12 01: Decode as Interleaved 2 of 5 10/11: Enable Deutsche 12	
Register	0x0071	
Bit	Feature	
Bit 7-4	Reserved	
Bit 3	1: Transmit Matrix 2 of 5 Check Digit	0: Do Not Transmit Matrix 2 of 5 Check Digit
Bit 2	1: Enable Matrix 2 of 5 Check Digit	0: Disable Matrix 2 of 5 Check Digit
Bit 1	Reserved	
Bit 0	1: Enable Matrix 2 of 5	0: Disable Matrix 2 of 5
Register	0x0072	
Bit	Feature	
Bit 7-4	Reserved	
Bit 3	1: Transmit Industrial 25 Check Digit	0: Do Not Transmit Industrial 25 Check Digit
Bit 2	1: Enable Industrial 25 Check Digit	0: Disable Industrial 25 Check Digit
Bit 1	Reserved	
Bit 0	1: Enable Industrial 25	0: Disable Industrial 25



W010F00

Exit Setup



W010F01

** Enter Setup

Register	0x0073	
Bit	Feature	
Bit 7-4	Reserved	
Bit 3	1: Transmit Standard 25 Check Digit	0: Do Not Transmit Standard 25 Check Digit
Bit 2	1: Enable Standard 25 Check Digit	0: Disable Standard 25 Check Digit
Bit 1	Reserved	
Bit 0	1: Enable Standard 25	0: Disable Standard 25
Register	0x0074	
Bit	Feature	
Bit 7-6	Reserved	
Bit 5	1: Enable Code 39 Full ASCII	0: Disable Code 39 Full ASCII
Bit 4	1: Transmit Code 39 Check Digit	0: Do Not Transmit Code 39 Check Digit
Bit 3	1: Enable Code 39 Check Digit	0: Disable Code 39 Check Digit
Bit 2	1: Transmit Code 39 Start/Stop Characters 0: Do Not Transmit Code 39 Start/Stop Characters	
Bit 1	Reserved	
Bit 0	1: Enable Code 39	0: Disable Code 39
Register	0x0075	
Bit	Feature	
Bit 7	Reserved	
Bit 6	1: Transmit Codabar Check Digit	0: Do Not Transmit Codabar Check Digit
Bit 5	1: Enable Codabar Check Digit	0: Disable Codabar Check Digit
Bit 4-3	Codabar Start/Stop Character Format: 00: ABCD/ABCD 01: ABCD/TN*E 10: abcd/abcd 11: abcd/tn*e	
Bit 2	1: Transmit Codabar Start/Stop Characters 0: Do Not Transmit Codabar Start/Stop Characters	
Bit 1	Reserved	
Bit 0	1: Enable Codabar	0: Disable Codabar



W010F00

Exit Setup



W010F01

** Enter Setup

Register	0x0076	
Bit	Feature	
Bit 7-4	Reserved	
Bit 3	1: Transmit Code 93 Check Digit	0: Do Not Transmit Code 93 Check Digit
Bit 2	1: Enable Code 93 Check Digit	0: Disable Code 93 Check Digit
Bit 1	Reserved	
Bit 0	1: Enable Code 93	0: Disable Code 93
Register	0x0077	
Bit	Feature	
Bit 7-6	Reserved	
Bit 5	1: Transmit Code 11 Check Digit	0: Do Not Transmit Code 11 Check Digit
Bit 4-2	Code 11 Check Digit Verification: 000: Disable 001: One Check Digit, MOD11 010: Two Check Digits, MOD11/MOD11 011: Two Check Digits, MOD11/MOD9 100: One Check Digit, MOD11 (Len <= 11); Two Check Digits, MOD11/MOD11 (Len > 11) 101: One Check Digit, MOD11 (Len <= 11); Two Check Digits, MOD11/MOD9 (Len > 11)	
Bit 1	Reserved	
Bit 0	1: Enable Code 11	0: Disable Code 11
Register	0x0078	
Bit	Feature	
Bit 7-4	Reserved	
Bit 3	1: Transmit Plessey Check Digit	0: Do Not Transmit Plessey Check Digit
Bit 2	1: Enable Plessey Check Digit	0: Disable Plessey Check Digit
Bit 1	Reserved	
Bit 0	1: Enable Plessey	0: Disable Plessey



W010F00

Exit Setup



W010F01

** Enter Setup

Register	0x0079	
Bit	Feature	
Bit 7-5	Reserved	
Bit 4	1: Transmit MSI-Plessey Check Digit	0: Do Not Transmit MSI-Plessey Check Digit
Bit 3-2	MSI-Plessey Check Digit Verification: 00: Disable 01: One Check Digit, MOD10 10: Two Check Digits, MOD10/MOD10 11: Two Check Digits, MOD10/MOD11	
Bit 1	Reserved	
Bit 0	1: Enable MSI-Plessey	0: Disable MSI-Plessey
Register	0x007A	
Bit	Feature	
Bit 7-3	Reserved	
Bit 2	1: Transmit RSS-14 Application Identifier	0: Do Not Transmit RSS-14 Application Identifier
Bit 1	Reserved	
Bit 0	1: Enable RSS-14	0: Disable RSS-14
Register	0x007B	
Bit	Feature	
Bit 7-3	Reserved	
Bit 2	1: Transmit RSS-Limited Application Identifier 0: Do Not Transmit RSS-Limited Application Identifier	
Bit 1	Reserved	
Bit 0	1: Enable RSS-Limited	0: Disable RSS-Limited
Register	0x007C	
Bit	Feature	
Bit 7-1	Reserved	
Bit 0	1: Enable RSS-Expand	0: Disable RSS-Expand



W010F00

Exit Setup



W010F01

** Enter Setup

Register	<i>0x0080</i>	
Bit		Feature
Bit 7-0	Set Code 128 Maximum Length	
Register	<i>0x0081</i>	
Bit		Feature
Bit 7-0	Set Code 128 Minimum Length	
Register	<i>0x0082</i>	
Bit		Feature
Bit 7-0	Set UCC/EAN-128 Maximum Length	
Register	<i>0x0083</i>	
Bit		Feature
Bit 7-0	Set UCC/EAN-128 Minimum Length	
Register	<i>0x0084</i>	
Bit		Feature
Bit 7-0	Set AIM 128 Maximum Length	
Register	<i>0x0085</i>	
Bit		Feature
Bit 7-0	Set AIM 128 Minimum Length	
Register	<i>0x0086</i>	
Bit		Feature
Bit 7-0	Set Interleaved 2 of 5 Maximum Length	
Register	<i>0x0087</i>	
Bit		Feature
Bit 7-0	Set Interleaved 2 of 5 Minimum Length	
Register	<i>0x0088</i>	
Bit		Feature
Bit 7-0	Set Matrix 2 of 5 Maximum Length	
Register	<i>0x0089</i>	
Bit		Feature
Bit 7-0	Set Matrix 2 of 5 Minimum Length	



W010F00

Exit Setup



W010F01

** Enter Setup

Register	<i>0x008A</i>
Bit	Feature
Bit 7-0	Set Industrial 25 Maximum Length
Register	<i>0x008B</i>
Bit	Feature
Bit 7-0	Set Industrial 25 Minimum Length
Register	<i>0x008C</i>
Bit	Feature
Bit 7-0	Set Standard 25 Maximum Length
Register	<i>0x008D</i>
Bit	Feature
Bit 7-0	Set Standard 25 Minimum Length
Register	<i>0x008E</i>
Bit	Feature
Bit 7-0	Set Code 39 Maximum Length
Register	<i>0x008F</i>
Bit	Feature
Bit 7-0	Set Code 39 Minimum Length
Register	<i>0x0090</i>
Bit	Feature
Bit 7-0	Set Codabar Maximum Length
Register	<i>0x0091</i>
Bit	Feature
Bit 7-0	Set Codabar Minimum Length
Register	<i>0x0092</i>
Bit	Feature
Bit 7-0	Set Code 93 Maximum Length
Register	<i>0x0093</i>
Bit	Feature
Bit 7-0	Set Code 93 Minimum Length



W010F00

Exit Setup



W010F01

** Enter Setup

Register	<i>0x0094</i>	
Bit		Feature
Bit 7-0	Set Code 11 Maximum Length	
Register	<i>0x0095</i>	
Bit		Feature
Bit 7-0	Set Code 11 Minimum Length	
Register	<i>0x0096</i>	
Bit		Feature
Bit 7-0	Set Plessey Maximum Length	
Register	<i>0x0097</i>	
Bit		Feature
Bit 7-0	Set Plessey Minimum Length	
Register	<i>0x0098</i>	
Bit		Feature
Bit 7-0	Set MSI-Plessey Maximum Length	
Register	<i>0x0099</i>	
Bit		Feature
Bit 7-0	Set MSI-Plessey Minimum Length	
Register	<i>0x00A1, 0x00A0</i>	
Bit		Feature
Bit 15-0	Set Code 128 Code ID ASCII value of one or two English letters (lower or upper case)	
Register	<i>0x00A3, 0x00A2</i>	
Bit		Feature
Bit 15-0	Set UCC/EAN-128 Code ID ASCII value of one or two English letters (lower or upper case)	
Register	<i>0x00A5, 0x00A4</i>	
Bit		Feature
Bit 15-0	Set AIM 128 Code ID ASCII value of one or two English letters (lower or upper case)	



W010F00

Exit Setup



W010F01

** Enter Setup

Register	<i>0x00A9, 0x00A8</i>	
Bit	Feature	
Bit 15-0	Set EAN-8 Code ID ASCII value of one or two English letters (lower or upper case)	
Register	<i>0x00AB, 0x00AA</i>	
Bit	Feature	
Bit 15-0	Set EAN-13 Code ID ASCII value of one or two English letters (lower or upper case)	
Register	<i>0x00AD, 0x00AC</i>	
Bit	Feature	
Bit 15-0	Set ISSN Code ID ASCII value of one or two English letters (lower or upper case)	
Register	<i>0x00B1, 0x00B0</i>	
Bit	Feature	
Bit 15-0	Set UPC-E Code ID ASCII value of one or two English letters (lower or upper case)	
Register	<i>0x00B3, 0x00B2</i>	
Bit	Feature	
Bit 15-0	Set UPC-A Code ID ASCII value of one or two English letters (lower or upper case)	
Register	<i>0x00B5, 0x00B4</i>	
Bit	Feature	
Bit 15-0	Set Interleaved 2 of 5 Code ID ASCII value of one or two English letters (lower or upper case)	
Register	<i>0x00B7, 0x00B6</i>	
Bit	Feature	
Bit 15-0	Set ITF-6 Code ID ASCII value of one or two English letters (lower or upper case)	



W010F00

Exit Setup



W010F01

** Enter Setup

Register	<i>0x00B9, 0x00B8</i>
Bit	Feature
Bit 15-0	Set ITF-14 Code ID ASCII value of one or two English letters (lower or upper case)
Register	<i>0x00BB, 0x00BA</i>
Bit	Feature
Bit 15-0	Set Deutsche 14 Code ID ASCII value of one or two English letters (lower or upper case)
Register	<i>0x00BD, 0x00BC</i>
Bit	Feature
Bit 15-0	Set Deutsche 12 Code ID ASCII value of one or two English letters (lower or upper case)
Register	<i>0x00BF, 0x00BE</i>
Bit	Feature
Bit 15-0	Set Matrix 2 of 5 Code ID ASCII value of one or two English letters (lower or upper case)
Register	<i>0x00C1, 0x00C0</i>
Bit	Feature
Bit 15-0	Set Industrial 25 Code ID ASCII value of one or two English letters (lower or upper case)
Register	<i>0x00C3, 0x00C2</i>
Bit	Feature
Bit 15-0	Set Standard 25 Code ID ASCII value of one or two English letters (lower or upper case)
Register	<i>0x00C5, 0x00C4</i>
Bit	Feature
Bit 15-0	Set Code 39 Code ID ASCII value of one or two English letters (lower or upper case)



W010F00

Exit Setup



W010F01

** Enter Setup

Register	<i>0x00C7, 0x00C6</i>
Bit	Feature
Bit 15-0	Set Codabar Code ID ASCII value of one or two English letters (lower or upper case)
Register	<i>0x00C9, 0x00C8</i>
Bit	Feature
Bit 15-0	Set Code 93 Code ID ASCII value of one or two English letters (lower or upper case)
Register	<i>0x00CB, 0x00CA</i>
Bit	Feature
Bit 15-0	Set Code 11 Code ID ASCII value of one or two English letters (lower or upper case)
Register	<i>0x00CD, 0x00CC</i>
Bit	Feature
Bit 15-0	Set Plessey Code ID ASCII value of one or two English letters (lower or upper case)
Register	<i>0x00CF, 0x00CE</i>
Bit	Feature
Bit 15-0	Set MSI-Plessey Code ID ASCII value of one or two English letters (lower or upper case)
Register	<i>0x00D1, 0x00D0</i>
Bit	Feature
Bit 15-0	Set RSS-14 Code ID ASCII value of one or two English letters (lower or upper case)
Register	<i>0x00D3, 0x00D2</i>
Bit	Feature
Bit 15-0	Set RSS-Limited Code ID ASCII value of one or two English letters (lower or upper case)
Register	<i>0x00D5, 0x00D4</i>
Bit	Feature
Bit 15-0	Set RSS-Expand Code ID ASCII value of one or two English letters (lower or upper case)



W010F00

Exit Setup



W010F01

** Enter Setup

Enable/Disable Barcode Programming

Scanning the **Enter Setup/Exit Setup** barcode can enable/disable barcode programming. After barcode programming is enabled, you can scan a number of programming barcodes to configure your scanner.

Barcode programming is on by default. In real application, programming barcodes hardly overlap with non-programming barcodes, so it is unnecessary to disable barcode programming each time you finish the configuration.

Programming Barcode Data

Programming barcode data (e.g. WFFD980) can be transmitted to the Host. To enable this feature, scan the appropriate barcode below. By default, the scanner does not transmit programming barcode data.

When the scanner is powered down or rebooted, this feature will be automatically disabled (i.e. the scanner does not transmit programming barcode data).



W060F06

Transmit Programming Barcode Data



W060F00

** Do Not Transmit Programming Barcode Data



W010F00

Exit Setup



W010F01

** Enter Setup

Factory Defaults

Scanning the following barcode can restore the scanner to the factory defaults.

You may need to reset your scanner when:

1. scanner is not properly configured so that it fails to decode barcodes;
2. you forget previous configuration and want to avoid its impact;
3. functions that are rarely used have been enabled for the time being.



WFFD980

Restore All Factory Defaults



W010F00

Exit Setup



W010F01

** Enter Setup

Scan Mode

Manual Mode

Manual Mode (default): A trigger pull activates a decode session. The decode session continues until the barcode is decoded or the trigger is released or the decode session timeout expires.



W030000

** Manual Mode

Decode Session Timeout: This parameter sets the maximum time decode session continues during a scan attempt. It is programmable in 1s increments from 1s to 255s. The default timeout is 15s. If the parameter is set to 0, the decode session timeout is infinite.



M00031D

Decode Session Timeout

Example: Set the decode session timeout to 5s

1. Scan the **Enter Setup** barcode.
2. Scan the **Decode Session Timeout** barcode.
3. Scan the numeric barcode "5". (See the **Digit Barcodes** section in Appendix)
4. Scan the **Save** barcode. (See the **Save/Cancel Barcodes** section in Appendix)
5. Scan the **Exit Setup** barcode.



W010F00

Exit Setup



W010F01

** Enter Setup

Continuous Mode

Continuous Mode: A trigger press activates the scanner to scan and decode at user-specified intervals, i.e. the timeout between decodes. Each decode session lasts until barcode is decoded or the decode session timeout expires. To suspend/resume the operation, simply press the trigger. By default, the scanner rereads same barcode with no delay.



W030002

Continuous Mode

Decode Session Timeout: This parameter sets the maximum time decode session continues during a scan attempt. It is programmable in 1s increments from 1s to 255s. The default timeout is 15s. If the parameter is set to 0, the decode session timeout is infinite.



M00031D

Decode Session Timeout

Example: Set the decode session timeout to 5s

1. Scan the **Enter Setup** barcode.
2. Scan the **Decode Session Timeout** barcode.
3. Scan the numeric barcode "5". (See the **Digit Barcodes** section in Appendix)
4. Scan the **Save** barcode. (See the **Save/Cancel Barcodes** section in Appendix)
5. Scan the **Exit Setup** barcode.



W010F00

Exit Setup



W010F01

** Enter Setup

Timeout between Decodes: This parameter sets the timeout between decode sessions. When a decode session ends, next session will not happen until the timeout between decodes expires. It is programmable in 0.1s increments from 0.0s to 25.5s. The default timeout is 1.0s.



M00031C

Timeout between Decodes

Example: Set the timeout between decodes to 5s

1. Scan the **Enter Setup** barcode.
2. Scan the **Timeout between Decodes** barcode.
3. Scan the numeric barcodes “5” and “0”. (See the **Digit Barcodes** section in Appendix)
4. Scan the **Save** barcode. (See the **Save/Cancel Barcodes** section in Appendix)
5. Scan the **Exit Setup** barcode.



W010F00

Exit Setup



W010F01

** Enter Setup

Reread Delay sets the time period before the scanner can read the same barcode a second time. It protects against accidental rereads of the same barcode. This parameter is programmable in 0.1s increments from 0.1s to 25.5s. The default delay is 3.0s. If the parameter is set to 0, the delay is infinite.

Note: This parameter only applies when the **Reread Same Barcode with a Delay** is enabled.



M00031E

Reread Delay

Reread Same Barcode with No Delay: The scanner is allowed to reread same barcode, ignoring the reread delay.

Reread Same Barcode with a Delay: The scanner is not allowed to reread same barcode before the reread delay expires.

To disable rereads of same barcode, enable the **Reread Same Barcode with a Delay** and set the delay to 0.



W100A00

** Reread Same Barcode with No Delay



W100A10

Reread Same Barcode with a Delay

Example: Set the reread delay to 5s

1. Scan the **Enter Setup** barcode.
2. Scan the **Reread Delay** barcode.
3. Scan the numeric barcodes “5” and “0”. (See the **Digit Barcodes** section in Appendix)
4. Scan the **Save** barcode. (See the **Save/Cancel Barcodes** section in Appendix)
5. Scan the **Exit Setup** barcode.



W010F00

Exit Setup



W010F01

** Enter Setup

Sense Mode

Sense Mode: The scanner activates a decode session every time when it detects a change in ambient illumination and meets the requirement of the image stabilization timeout. Decode session continues until barcode is decoded or the decode session timeout expires. A trigger pull can also activate a decode session. By default, the scanner rereads same barcode with no delay.



W030003

Sense Mode

Decode Session Timeout: This parameter sets the maximum time decode session continues during a scan attempt. It is programmable in 1s increments from 1s to 255s. The default timeout is 15s. If the parameter is set to 0, the decode session timeout is infinite.



M00031D

Decode Session Timeout

Example: Set the decode session timeout to 5s

1. Scan the **Enter Setup** barcode.
2. Scan the **Decode Session Timeout** barcode.
3. Scan the numeric barcode “5”. (See the **Digit Barcodes** section in Appendix)
4. Scan the **Save** barcode. (See the **Save/Cancel Barcodes** section in Appendix)
5. Scan the **Exit Setup** barcode.



W010F00

Exit Setup



W010F01

** Enter Setup

Image Stabilization Timeout: The scanner waits for the image stabilization timeout to expire before activating a decode session every time it detects a change in ambient illumination. This parameter is programmable in 0.1s increments from 0.0s to 25.5s. The default timeout is 0.4s.



M00031B

Image Stabilization Timeout

Example: Set the Image Stabilization Timeout to 5s

1. Scan the **Enter Setup** barcode.
2. Scan the **Image Stabilization Timeout** barcode.
3. Scan the numeric barcodes “5” and “0”. (See the **Digit Barcodes** section in Appendix)
4. Scan the **Save** barcode. (See the **Save/Cancel Barcodes** section in Appendix)
5. Scan the **Exit Setup** barcode.



W010F00

Exit Setup



W010F01

** Enter Setup

Reread Delay sets the time period before the scanner can read the same barcode a second time. It protects against accidental rereads of the same barcode. This parameter is programmable in 0.1s increments from 0.1s to 25.5s. The default delay is 3.0s. If the parameter is set to 0, the delay is infinite.

Note: This parameter only applies when the **Reread Same Barcode with a Delay** is enabled.



M00031E

Reread Delay

Reread Same Barcode with No Delay: The scanner is allowed to reread same barcode, ignoring the reread delay.

Reread Same Barcode with a Delay: The scanner is not allowed to reread same barcode before the reread delay expires.

To disable rereads of same barcode, enable the **Reread Same Barcode with a Delay** and set the delay to 0.



W100A00

** Reread Same Barcode with No Delay



W100A10

Reread Same Barcode with a Delay

Example: Set the reread delay to 5s

1. Scan the **Enter Setup** barcode.
2. Scan the **Reread Delay** barcode.
3. Scan the numeric barcodes “5” and “0”. (See the **Digit Barcodes** section in Appendix)
4. Scan the **Save** barcode. (See the **Save/Cancel Barcodes** section in Appendix)
5. Scan the **Exit Setup** barcode.



W010F00

Exit Setup



W010F01

** Enter Setup

Sensitivity: This parameter specifies the degree of acuteness of the scanner's response to changes in ambient illumination. The higher the sensitivity, the lower requirement in illumination change to trigger the scanner. You can select an appropriate degree of sensitivity that fits the ambient environment.



WFF0305

High Sensitivity



WFF0310

** Medium Sensitivity



WFF0330

** Medium Sensitivity



M00031A

Custom Sensitivity

Sensitivity levels range from 0 to 255. The smaller the number, the higher the sensitivity.

Example: Set the sensitivity level to 10

1. Scan the **Enter Setup** barcode.
2. Scan the **Custom Sensitivity** barcode.
3. Scan the numeric barcodes "1" and "0". (See the **Digit Barcodes** section in Appendix)
4. Scan the **Save** barcode. (See the **Save/Cancel Barcodes** section in Appendix)
5. Scan the **Exit Setup** barcode.



W010F00

Exit Setup



W010F01

** Enter Setup

Command Trigger Mode

Command Trigger Mode: Decode session is activated by a host command. The decode session continues until the barcode is decoded or the decode session timeout expires.



W030001

Command Trigger Mode

Decode Session Timeout: This parameter sets the maximum time decode session continues during a scan attempt. It is programmable in 1s increments from 1s to 255s. The default timeout is 15s. If the parameter is set to 0, the decode session timeout is infinite.



M00031D

Decode Session Timeout

Example: Set the decode session timeout to 5s

1. Scan the **Enter Setup** barcode.
2. Scan the **Decode Session Timeout** barcode.
3. Scan the numeric barcode "5". (See the **Digit Barcodes** section in Appendix)
4. Scan the **Save** barcode. (See the **Save/Cancel Barcodes** section in Appendix)
5. Scan the **Exit Setup** barcode.



W010F00

Exit Setup



W010F01

** Enter Setup

Security Level

This parameter specifies the number of times to decode a barcode during a scan attempt. The higher the security level, the lower the error rate and decoding efficiency.



W030A00

** Set Security Level to 0



W030A01

Set Security Level to 1



W030A02

Set Security Level to 2



W030A03

Set Security Level to 3



W010F00

Exit Setup



W010F01

** Enter Setup

Good Read Beep



W041204

** Good Read Beep On



W041200

Good Read Beep Off



W010F00

Exit Setup



W010F01

** Enter Setup

Good Read Beep Frequency



WFF10DA

Low



WFF104B

** Medium



WFF1025

High

Good Read Beep Duration

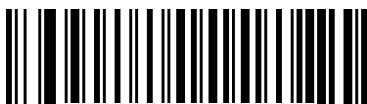

WFF111F

40ms



WFF113E

**80ms



WFF115D

120ms



W010F00

Exit Setup



W010F01

** Enter Setup

Decode Result Notification

When enabled, if a barcode does not decode, "F" is transmitted; if a barcode is decoded, "S" is appended to the barcode data as the most left character.



W203120

Enable Decode Result Notification



W203100

** Disable Decode Result Notification



W010F00

Exit Setup



W010F01

** Enter Setup

Other Settings

You can change the following parameter settings temporarily and the changes will be lost when you power down or reboot the scanner.

Silent Mode



W400000

Silent Mode On



W400040

** Silent Mode Off

Note: This feature is only applicable to decode beep and will be automatically disabled when the scanner is powered down or rebooted.

Illumination



W0C0000

Off



W0C0008

Always On



W0C0004

** On When Scanning



W010F00

Exit Setup



W010F01

** Enter Setup

Chapter 3 Communication Settings

Introduction

The scanner provides an RS-232 interface, a USB interface and a PS/2 interface (hardware version: V2 or higher) to communicate with the host device. The host device can receive scanned data and send commands to control the scanner or to access/alter the configuration information of the scanner via the RS-232 or USB or PS/2 interface.

RS-232 Interface

Serial communication interface is usually used to connect the scanner to a host device (like PC, POS). When the scanner is connected to a host device through its RS-232 interface, you need to set communication parameters to match the host device.



W010F00

Exit Setup



W010F01

** Enter Setup

Baud Rate

Baud rate is the number of bits of data transmitted per second. Set the scanner's baud rate to match the Host requirements.



WFFD9D3

** 9600



WFFD9D0

1200



WFFD9D5

19200



WFFD9D1

2400



WFFD9D6

38400



WFFD9D2

4800



WFFD9D7

57600



WFFD9D4

14400



WFFD9D8

115200



W010F00

Exit Setup



W010F01
** Enter Setup

Parity Check



W062900
** None



W062906
Even Parity



W062904
Odd Parity

Stop Bit



W012900
** 1 Stop Bit



W012901
2 Stop Bits



W010F00
Exit Setup



W010F01

** Enter Setup

Data Bit



W082908

8 Data Bits



W0F2908

** 8 Data Bits, No Parity, 1 Stop Bit



W0F290E

8 Data Bits, Even Parity, 1 Stop Bit



W0F290C

8 Data Bits, Odd Parity, 1 Stop Bit



W0F2909

8 Data Bits, No Parity, 2 Stop Bits



W0F290F

8 Data Bits, Even Parity, 2 Stop Bits



W0F290D

8 Data Bits, Odd Parity, 2 Stop Bits



W082900

7 Data Bits



W010F00

Exit Setup



W010F01

** Enter Setup



W0F2906

7 Data Bits, Even Parity, 1 Stop Bit



W0F2904

7 Data Bits, Odd Parity, 1 Stop Bit



W0F2907

7 Data Bits, Even Parity, 2 Stop Bits



W0F2905

7 Data Bits, Odd Parity, 2 Stop Bits



W010F00

Exit Setup



W010F01

** Enter Setup

USB Interface

When the scanner is connected to a host device through its USB interface, **USB HID-KBW** is enabled by default. User can switch between options – **USB DATAPIPE**, **USB HID-KBW**, **USB COM Port Emulation** and **HID-POS**, upon actual need.

USB HID-KBW



W070901

** USB HID-KBW



W010F00

Exit Setup



W010F01

** Enter Setup

Standard Keyboard

When the USB HID-KBW feature is enabled, the scanner selects **Standard Keyboard** by default. Besides that, the other two options are provided: **Emulate ALT+Keypad** and **Function Key Mapping**.



W031A00

** Standard Keyboard

Emulate ALT+Keypad

When **Emulate ALT+Keypad** is enabled, any ASCII character (0x00 - 0xFF) is sent over the numeric keypad no matter which keyboard type is selected. Since sending a character involves multiple keystroke emulations, this method appears less efficient.

1. ALT Make
2. Enter the number corresponding to the ASCII character on the keypad.
3. ALT Break



W031A03

Emulate ALT+Keypad

Note: It is recommended to turn on the Num Lock light on the host when using this feature.



W010F00

Exit Setup



W010F01

** Enter Setup

Function Key Mapping

When **Function Key Mapping** is enabled, function character (0x00 - 0x1F) are sent as ASCII sequences over the numeric keypad.

1. CTRL Make
2. Press function key (Refer to the **ASCII Function Key Mapping Table** on the following page)
3. CTRL Break



W031A01

Function Key Mapping



W010F00

Exit Setup



W010F01

** Enter Setup

ASCII Function Key Mapping Table

ASCII Value (HEX)	Function Key	ASCII Value (HEX)	Function Key
00	2	10	P
01	A	11	Q
02	B	12	R
03	C	13	S
04	D	14	T
05	E	15	U
06	F	16	V
07	G	17	W
08	H	18	X
09	I	19	Y
0A	J	1A	Z
0B	K	1B	[
0C	L	1C	\
0D	M	1D]
0E	N	1E	6
0F	O	1F	.



W010F00

Exit Setup



W010F01

** Enter Setup

USB Country Keyboard Types

Keyboard layouts vary from country to country. All supported keyboard types are listed below.



WFF1900

** 1 - U.S.



WFF1901

2 - Belgium



WFF1902

3 - Brazil



WFF1903

4 - Canada



WFF1904

5 - Czech



WFF1905

6 - Denmark



WFF1906

7 - Finland



WFF1907

8 - France



W010F00

Exit Setup



W010F01

** Enter Setup



WFF1908

9 - Austria



WFF1909

10 - Greece



WFF190A

11 - Hungary



WFF190B

12 - Israel



WFF190C

13 - Italy



WFF190D

14 - Latin America



WFF190E

15 - Netherland



WFF190F

16 - Norway



WFF1910

17 - Poland



WFF1911

18 - Portugal



W010F00

Exit Setup



W010F01

** Enter Setup



WFF1912

19 - Romania



WFF1913

20 - Russia



WFF1915

21 - Slovakia



WFF1916

22 - Spain



WFF1917

23 - Sweden



WFF1918

24 - Switzerland



WFF1919

25 - Turkey1



WFF191A

26 - Turkey2



WFF191B

27 - UK



WFF191C

28 - Japan



W010F00

Exit Setup



W010F01

** Enter Setup

Inter-Keystroke Delay

This parameter specifies the delay between emulated keystrokes.



WC01A00

** No Delay



WC01A40

Short Delay (5ms)



WC01A80

Medium Delay (10ms)



WC01AC0

Long Delay (15ms)



W010F00

Exit Setup



W010F01

** Enter Setup

Convert Case

This parameter is valid when the **Standard Keyboard** or **Function Key Mapping** is enabled.



W381A00

** No Case Conversion



W381A20

Convert All to Upper Case



W381A30

Convert All to Lower Case



W381A08

Invert Upper and Lower Case Characters

Example: When the **Convert All to Lower Case** feature is enabled, barcode data “AbC” is transmitted as “abc”.



W010F00

Exit Setup



W010F01

** Enter Setup

Emulate Numeric Keypad

When this feature is disabled, sending barcode data is emulated as keystroke(s) on main keyboard.

To enable this feature, scan the **Emulate Numeric Keypad** barcode. Sending a number (0-9) is emulated as keystroke on numeric keypad, whereas sending other character like “+”, “_”, “*”, “/” and “.” is still emulated as keystroke on main keyboard. However, this feature is influenced by the state of the Num Lock key on the host: if the Num Lock light on the host is ON, numbers are sent over numeric keypad, if it is OFF, numbers are sent over main keyboard.



W041A04

Emulate Numeric Keypad



W041A00

** Do Not Emulate Numeric Keypad

Note: Make sure the Num Lock light of the Host is turned ON when using this feature.

Emulate ALT+Keypad ON prevails over **Emulate Numeric Keypad**.



W010F00

Exit Setup



W010F01

** Enter Setup

USB COM Port Emulation

This feature allows the host to receive data in the way as a serial port does. However, you need to set communication parameters on the scanner to match the Host requirements. A driver is required for this feature.



W070902

USB COM Port Emulation



W010F00

Exit Setup



W010F01

** Enter Setup

USB DataPipe

A driver is required when using this protocol to communicate with the scanner.



W070900

USB DataPipe



W010F00

Exit Setup



W010F01

** Enter Setup

HID-POS

The HID-POS interface is recommended for new application programs. It can send up to 56 characters in a single USB report and appears more efficient than USB HID-KBW.

Features:

- ✧ HID based, no custom driver required.
- ✧ Way more efficient in communication than USB HID-KBW and traditional RS-232 interface.

Note: HID-POS does not require a custom driver. However, a HID interface on Windows 98 does. All HID interfaces employ standard driver provided by the operating system. Use defaults when installing the driver.



W070903

HID-POS



W010F00

Exit Setup



W010F01

** Enter Setup

Access the Scanner with Your Program

1. Use CreateFile to access the scanner as a HID device.
2. Use ReadFile to deliver the scanned data to the application program.
3. Use WriteFile to send data to the scanner.

Acquire Scanned Data

After a barcode is decoded, the scanner sends an input report as below:

Byte	Bit							
	7	6	5	4	3	2	1	0
0	Report ID = 02							
1	Barcode Length							
2-57	Decoded Data (1-56)							
58-61	Reserved (1-4)							
62	00							
63	00 (no data continued) or 01 (data continued)							

VID/PID

USB uses VID (Vendor ID) and PID (Product ID) to identify and locate a device. The VID is assigned by USB Implementers Forum. SUNLUX's vendor ID is 1EAB (Hex). A range of PIDs are used for each Newland product family. Every PID contains a base number and interface type (keyboard, COM port, etc.).

Product	Interface	PID (Hex)	PID (Dec)
XL-626	USB DataPipe	8001	32769
	USB HID-KBW	8003	32771
	USB COM Port Emulation	8002	32770
	HID-POS	8010	32784



W010F00

Exit Setup



W010F01

** Enter Setup

PS/2 Interface (Hardware Version: V2 or higher)

When the scanner is connected to a host device through its PS/2 interface, users need to scan the following barcode to enable the PS/2 port.



W100910

PS/2-KBW

To switch from PS/2 to RS-232, scan the barcode below.

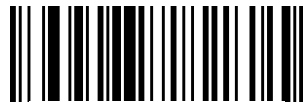

W100900

RS-232



W010F00

Exit Setup



W010F01

** Enter Setup

Chapter 4 Data Formatting

Introduction

After a successful barcode read, a string containing numbers, letters or symbols will be returned.

In real applications, barcode data may be found insufficient for your needs. You may wish to include additional information such as barcode type, data acquisition time or delimiter in data being scanned.

Adding extra information to printed barcodes does not seem like a sensible solution since that will increase the barcode size and make them inflexible. Instead, we come up with the idea of appending prefix and suffix to the data without making any change to barcodes. We will show you how to conduct the configuration in the following sections.

Note: Customized data: <Prefix> <Data><Suffix><Terminating Character>

Prefix Sequence



W013100

** Code ID+Custom+AIM ID



W013101

Custom+Code ID+ AIM ID



W010F00

Exit Setup



W010F01

** Enter Setup

Custom Prefix

Enable/Disable Custom Prefix

If custom prefix is enabled, you are allowed to append to the data a user-defined prefix that cannot exceed 5 characters.

For example, if barcode data is “123” and custom prefix is “AB”, the Host will receive “AB123”.



W043104

Enable Custom Prefix



W043100

** Disable Custom Prefix

Set Custom Prefix

To set a custom prefix, scan the **Set Custom Prefix** barcode, the numeric barcodes corresponding to the hexadecimal value of a desired prefix and the **Save** barcode.

Note: A custom prefix cannot exceed 5 characters.



M000100

Set Custom Prefix

Example: Set the custom prefix to “CODE” (its hexadecimal value is 0x43/0x4F/0x44/0x45)

1. Scan the **Enter Setup** barcode.
2. Scan the **Set Custom Prefix** barcode.
3. Scan the numeric barcodes “4”, “3”, “4”, “F”, “4”, “4”, “4” and “5”. (See the **Digit Barcodes** section in Appendix)
4. Scan the **Save** barcode. (See the **Save/Cancel Barcodes** section in Appendix)
5. Scan the **Enable Custom Prefix** barcode.
6. Scan the **Exit Setup** barcode.



W010F00

Exit Setup



W010F01

** Enter Setup

AIM ID Prefix

AIM (Automatic Identification Manufacturers) ID defines symbology identifier (For the details, see the **AIM ID Table** section in Appendix). If AIM ID prefix is enabled, the scanner will add the symbology identifier before the scanned data after decoding.



W186018

Enable AIM ID Prefix



W186000

** Disable AIM ID Prefix



W010F00

Exit Setup



W010F01

** Enter Setup

CODE ID Prefix

Code ID can also be used to identify barcode type. Unlike AIM ID, Code ID is user programmable. For the information of default Code ID, see the **Code ID Table** section in Appendix.



W023102

Enable CODE ID Prefix



W023100

** Disable CODE ID Prefix

Restore All Default Code IDs



WFFD9C2

Restore All Default Code IDs

Set Code ID

Code ID can only consist of one or two English letters. To set a Code ID, scan a **Set Code ID** barcode, the numeric barcodes corresponding to the hexadecimal value of a desired ID and the **Save** barcode.

Example: Set the Code ID of Code 128 to “p” (its hexadecimal value is 0x70)

1. Scan the **Enter Setup** barcode.
2. Scan the **Set Code 128 Code ID** barcode. (See the barcode on the following page)
3. Scan the numeric barcodes “7” and “0”. (See the **Digit Barcodes** section in Appendix)
4. Scan the **Save** barcode. (See the **Save/Cancel Barcodes** section in Appendix)
5. Scan the **Exit Setup** barcode.



W010F00

Exit Setup



W010F01

** Enter Setup

Set Code ID Barcodes



M000200

Set Code 128 Code ID



M000201

Set UCC/EAN-128 Code ID



M000202

Set AIM 128 Code ID



M000204

Set EAN-8 Code ID



M000205

Set EAN-13 Code ID



M000206

Set ISSN Code ID



M000207

Set ISBN Code ID



M000208

Set UPC-E Code ID



W010F00

Exit Setup



W010F01

** Enter Setup

Set Code ID Barcodes (continued)



M000209

Set UPC-A Code ID



M00020A

Set Interleaved 2 of 5 Code ID



M00020B

Set ITF-6 Code ID



M00020C

Set ITF-14 Code ID



M00020D

Set Deutsche 14 Code ID



M00020E

Set Deutsche 12 Code ID



M00020F

Set Matrix 2 of 5 Code ID



M000210

Set Industrial 25 Code ID



W010F00

Exit Setup



W010F01

** Enter Setup

Set Code ID Barcodes (continued)



M000211

Set Standard 25 Code ID



M000212

Set Code 39 Code ID



M000213

Set Codabar Code ID



M000214

Set Code 93 Code ID



M000215

Set Code 11 Code ID



M000216

Set Plessey Code ID



M000217

Set MSI-Plessey Code ID



M000218

Set RSS-14 Code ID



M000219

Set RSS-Limited Code ID



M00021A

Set RSS-Expand Code ID



W010F00

Exit Setup



W010F01

** Enter Setup

Custom Suffix

Enable/Disable Custom Suffix

If custom suffix is enabled, you are allowed to append to the data a user-defined suffix that cannot exceed 5 characters.

For example, if barcode data is “123” and custom suffix is “AB”, the Host will receive “123AB”.



W083108

Enable Custom Suffix



W083100

** Disable Custom Suffix



W010F00

Exit Setup



W010F01

** Enter Setup

Set Custom Suffix

To set a custom suffix, scan the **Set Custom Suffix** barcode, the numeric barcodes corresponding to the hexadecimal value of a desired suffix and the **Save** barcode.

Note: A custom suffix cannot exceed 5 characters.



M000101

Set Custom Suffix

Example: Set the custom suffix to “AGE” (its hexadecimal value is 0x41/0x47/0x45)

1. Scan the **Enter Setup** barcode.
2. Scan the **Set Custom Suffix** barcode.
3. Scan the numeric barcodes “4”“1”“4”“7”“4” and “5”. (See the **Digit Barcodes** section in Appendix)
4. Scan the **Save** barcode. (See the **Save/Cancel Barcodes** section in Appendix)
5. Scan the **Enable Custom Suffix** barcode.
6. Scan the **Exit Setup** barcode.



W010F00

Exit Setup



W010F01

** Enter Setup

Terminating Character Suffix

A terminating character, such as carriage return (CR) and line feed (LF), can be used to mark the end of data, which means nothing can be added after it.

A terminating character suffix cannot exceed 5 characters.

Enable/Disable Terminating Character Suffix

To enable/disable terminating character suffix, scan the appropriate barcode below.



W103110

** Enable Terminating Character Suffix



W103100

Disable Terminating Character Suffix



W010F00

Exit Setup



W010F01

** Enter Setup

Set Terminating Character Suffix

The scanner provides a shortcut for setting the terminating character suffix to 0x0D (CR) or 0x0D,0x0A (CRLF) or 0x09 (Horizontal Tab) by scanning the following barcode.



W F F D 9 C 3

Terminating Character 0x0D



W F F D 9 C 4

** Terminating Character 0x0D,0x0A



W F F D 9 C 5

Terminating Character 0x09



M000102

Set Terminating Character Suffix

To set other terminating character suffix, scan the **Set Terminating Character Suffix** barcode, the numeric barcodes corresponding to the hexadecimal value of a desired terminating character, and the **Save** barcode.

Note: A terminating character suffix cannot exceed 5 characters.

Example: Set the terminating character suffix to 0x0A

1. Scan the **Enter Setup** barcode.
2. Scan the **Set Terminating Character Suffix** barcode.
3. Scan the numeric barcodes “0” and “A”. (See the **Digit Barcodes** section in Appendix)
4. Scan the **Save** barcode. (See the **Save/Cancel Barcodes** section in Appendix)
5. Scan the **Enable Terminating Character Suffix** barcode.
6. Scan the **Exit Setup** barcode.



W010F00

Exit Setup



W010F01

** Enter Setup

Chapter 5 Symbologies

Introduction

Every symbology (barcode type) has its own unique attributes. This chapter provides programming barcodes for configuring the scanner so that it can identify various barcode symbologies. It is recommended to disable those that are rarely used to increase the efficiency of the scanner.

Global Settings

Enable/Disable All Symbologies

If all symbologies are disabled, the scanner can only identify programming barcodes.



WFFD981

Enable All Symbologies



WFFD982

Disable All Symbologies



W010F00

Exit Setup



W010F01

** Enter Setup

Code 128

Restore Factory Defaults



WFFD990

Restore the Factory Defaults of Code 128

Enable/Disable Code 128



W016101

** Enable Code 128



W016100

Disable Code 128



W010F00

Exit Setup



W010F01

** Enter Setup

Set Length Range for Code 128

The scanner can be configured to only decode Code 128 barcodes with lengths that fall between (inclusive) the minimum and maximum lengths.

The supported maximum length is 255 characters. If minimum length is set to be greater than maximum length, the scanner only decodes Code 128 barcodes with either the minimum or maximum length. If minimum length is same as maximum length, only Code 128 barcodes with that length are to be decoded.



M000301

Set the Minimum Length



M000300

Set the Maximum Length

Example: Set the scanner to decode Code128 barcodes containing between 8 and 12 characters

1. Scan the **Enter Setup** barcode.
2. Scan the **Set the Minimum Length** barcode.
3. Scan the numeric barcode “8”. (See the **Digit Barcodes** section in Appendix)
4. Scan the **Save** barcode. (See the **Save/Cancel Barcodes** section in Appendix)
5. Scan the **Set the Maximum Length** barcode.
6. Scan the numeric barcodes “1” and “2”.
7. Scan the **Save** barcode.
8. Scan the **Exit Setup** barcode.



W010F00

Exit Setup



W010F01

** Enter Setup

UCC/EAN-128

Restore Factory Defaults



WFFD991

Restore the Factory Defaults of UCC/EAN-128

Enable/Disable UCC/EAN-128



W036203

** Enable UCC/EAN-128



W036200

Disable UCC/EAN-128



W036201

Decode as Code 128



W010F00

Exit Setup



W010F01

** Enter Setup

Set Length Range for UCC/EAN-128

The scanner can be configured to only decode UCC/EAN-128 barcodes with lengths that fall between (inclusive) the minimum and maximum lengths.

The supported maximum length is 255 characters. If minimum length is set to be greater than maximum length, the scanner only decodes UCC/EAN-128 barcodes with either the minimum or maximum length. If minimum length is same as maximum length, only UCC/EAN-128 barcodes with that length are to be decoded.



M000303

Set the Minimum Length



M000302

Set the Maximum Length

Example: Set the scanner to decode UCC/EAN-128 barcodes containing between 8 and 12 characters

1. Scan the **Enter Setup** barcode.
2. Scan the **Set the Minimum Length** barcode.
3. Scan the numeric barcode “8”. (See the **Digit Barcodes** section in Appendix)
4. Scan the **Save** barcode. (See the **Save/Cancel Barcodes** section in Appendix)
5. Scan the **Set the Maximum Length** barcode.
6. Scan the numeric barcodes “1” and “2”.
7. Scan the **Save** barcode.
8. Scan the **Exit Setup** barcode.



W010F00

Exit Setup



W010F01

** Enter Setup

AIM 128

Restore Factory Defaults



WFFD992

Restore the Factory Defaults of AIM 128

Enable/Disable AIM 128



W036302

Enable AIM 128



W036300

** Disable AIM 128



W036301

Decode as Code 128



W010F00

Exit Setup



W010F01

** Enter Setup

Set Length Range for AIM 128

The scanner can be configured to only decode AIM 128 barcodes with lengths that fall between (inclusive) the minimum and maximum lengths.

The supported maximum length is 255 characters. If minimum length is set to be greater than maximum length, the scanner only decodes AIM 128 barcodes with either the minimum or maximum length. If minimum length is same as maximum length, only AIM 128 barcodes with that length are to be decoded.



M000305

Set the Minimum Length



M000304

Set the Maximum Length

Example: Set the scanner to decode AIM128 barcodes containing between 8 and 12 characters

1. Scan the **Enter Setup** barcode.
2. Scan the **Set the Minimum Length** barcode.
3. Scan the numeric barcode “8”. (See the **Digit Barcodes** section in Appendix)
4. Scan the **Save** barcode. (See the **Save/Cancel Barcodes** section in Appendix)
5. Scan the **Set the Maximum Length** barcode.
6. Scan the numeric barcodes “1” and “2”.
7. Scan the **Save** barcode.
8. Scan the **Exit Setup** barcode.



W010F00

Exit Setup



W010F01
** Enter Setup

EAN-8

Restore Factory Defaults



WFFD994
Restore the Factory Defaults of EAN-8

Enable/Disable EAN-8



W016501
** Enable EAN-8



W016500
Disable EAN-8

Transmit Check Digit

EAN-8 is 8 digits in length with the last one as its check digit used to verify the integrity of the data.



W046504
** Transmit EAN-8 Check Digit



W046500
Do Not Transmit EAN-8 Check Digit



W010F00
Exit Setup



W010F01

** Enter Setup

Add-On Code

An EAN-8 barcode can be augmented with a two-digit or five-digit add-on code to form a new one. In the examples below, the part surrounded by blue dotted line is an EAN-8 barcode while the part circled by red dotted line is add-on code.



W106510

Enable 2-Digit Add-On Code



W106500

** Disable 2-Digit Add-On Code



W206520

Enable 5-Digit Add-On Code



W206500

** Disable 5-Digit Add-On Code

Enable 2-Digit Add-On Code/ Enable 5-Digit Add-On Code: The scanner decodes a mix of EAN-8 barcodes with and without 2-digit/5-digit add-on codes.

Disable 2-Digit Add-On Code/ Disable 5-Digit Add-On Code: The scanner decodes EAN-8 and ignores the add-on code when presented with an EAN-8 plus add-on barcode. It can also decode EAN-8 barcodes without add-on codes.



W010F00

Exit Setup



W010F01

** Enter Setup

Add-On Code Required

This parameter is only valid when **Enable 2-Digit Add-On Code** and/or **Enable 5-Digit Add-On Code** is selected.



W086508

EAN-8 Add-On Code Required



W086500

** EAN-8 Add-On Code Not Required

EAN-8 Extension

Disable EAN-8 Zero Extend: Transmit EAN-8 barcodes as is.

Enable EAN-8 Zero Extend: Add five leading zeros to decoded EAN-8 barcodes to extend to 13 digits.

Convert EAN-8 to EAN-13: Add five leading zeros to decoded EAN-8 barcodes to make them compatible in format to EAN-13 barcodes.



WC06540

Enable EAN-8 Zero Extend



WC06500

** Disable EAN-8 Zero Extend



WC06580

Convert EAN-8 to EAN-13



W010F00

Exit Setup



W010F01

** Enter Setup

EAN-13

Restore Factory Defaults



WFFD995

Restore the Factory Defaults of EAN-13

Enable/Disable EAN-13



W016601

** Enable EAN-13



W016600

Disable EAN-13

Transmit Check Digit

EAN-13 is 13 digits in length with the last one as its check digit used to verify the integrity of the data.



W046604

** Transmit EAN-13 Check Digit

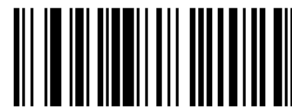

W046600

Do Not Transmit EAN-13 Check Digit



W010F00

Exit Setup



W010F01

** Enter Setup

Add-On Code

An EAN-13 barcode can be augmented with a two-digit or five-digit add-on code to form a new one. In the examples below, the part surrounded by blue dotted line is an EAN-13 barcode while the part circled by red dotted line is add-on code.



W106610

Enable 2-Digit Add-On Code



W106600

** Disable 2-Digit Add-On Code



W206620

Enable 5-Digit Add-On Code



W206600

** Disable 5-Digit Add-On Code

Enable 2-Digit Add-On Code/ Enable 5-Digit Add-On Code: The scanner decodes a mix of EAN-13 barcodes with and without 2-digit/5-digit add-on codes.

Disable 2-Digit Add-On Code/ Disable 5-Digit Add-On Code: The scanner decodes EAN-13 and ignores the add-on code when presented with an EAN-13 plus add-on barcode. It can also decode EAN-13 barcodes without add-on codes.



W010F00

Exit Setup



W010F01

** Enter Setup

Add-On Code Required

This parameter is only valid when **Enable 2-Digit Add-On Code** and/or **Enable 5-Digit Add-On Code** is selected.



W086608

EAN-13 Add-On Code Required



W086600

** EAN-13 Add-On Code Not Required



W010F00

Exit Setup



W010F01

** Enter Setup

ISSN

Restore Factory Defaults



WFFD996

Restore the Factory Defaults of ISSN

Enable/Disable ISSN



W036702

Enable ISSN



W036700

** Disable ISSN



W036701

Decode as EAN-13



W010F00

Exit Setup



W010F01

** Enter Setup

ISBN

Restore Factory Defaults



WFFD997

Restore the Factory Defaults of ISBN

Enable/Disable ISBN



W036802

Enable ISBN



W036800

** Disable ISBN



W036801

Decode as EAN-13



W010F00

Exit Setup



W010F01

** Enter Setup

Set ISBN Format



W086800

** ISBN-13



W086808

ISBN-10



W010F00

Exit Setup



W010F01

** Enter Setup

UPC-E

Restore Factory Defaults



WFFD998

Restore the Factory Defaults of UPC-E

Enable/Disable UPC-E



W016901

** Enable UPC-E



W016900

Disable UPC-E

Transmit Check Digit

UPC-E is 8 digits in length with the last one as its check digit used to verify the integrity of the data.



W046904

** Transmit UPC-E Check Digit



W046900

Do Not Transmit UPC-E Check Digit



W010F00

Exit Setup



W010F01

** Enter Setup

Add-On Code

A UPC-E barcode can be augmented with a two-digit or five-digit add-on code to form a new one. In the examples below, the part surrounded by blue dotted line is a UPC-E barcode while the part circled by red dotted line is add-on code.



W106910

Enable 2-Digit Add-On Code



W106900

** Disable 2-Digit Add-On Code



W206920

Enable 5-Digit Add-On Code



W206900

** Disable 5-Digit Add-On Code

Enable 2-Digit Add-On Code/ Enable 5-Digit Add-On Code: The scanner decodes a mix of UPC-E barcodes with and without 2-digit/5-digit add-on codes.

Disable 2-Digit Add-On Code/ Disable 5-Digit Add-On Code: The scanner decodes UPC-E and ignores the add-on code when presented with a UPC-E plus add-on barcode. It can also decode UPC-E barcodes without add-on codes.



W010F00

Exit Setup



W010F01

** Enter Setup

Add-On Code Required

This parameter is only valid when **Enable 2-Digit Add-On Code** and/or **Enable 5-Digit Add-On Code** is selected.



W086908

UPC-E Add-On Code Required



W086900

** UPC-E Add-On Code Not Required

Transmit System Character

The first character of UPC-E barcode is the system character.



W306A10

Do Not Transmit System Character



W306A20

** Transmit System Character



W010F00

Exit Setup



W010F01

** Enter Setup

UPC-E Extension

Disable UPC-E Extend: Transmit UPC-E barcodes as is.

Enable UPC-E Extend: Extend UPC-E barcodes to make them compatible in length to UPC-A.

Convert UPC-E to UPC-A: Extend UPC-E barcodes to make them compatible in format to UPC-A.



WC06940

Enable UPC-E Extend



WC06900

**Disable UPC-E Extend



WC06980

Convert UPC-E to UPC-A



W010F00

Exit Setup



W010F01

** Enter Setup

UPC-A

Restore Factory Defaults



WFFD999

Restore the Factory Defaults of UPC-A

Enable/Disable UPC-A



W036B02

** Enable UPC-A



W036B00

Disable UPC-A



W036B01

Decode as EAN-13



W010F00

Exit Setup



W010F01

** Enter Setup

Transmit Check Digit

UPC-A is 13 digits in length with the last one as its check digit used to verify the integrity of the data.



W086B08

** Transmit UPC-A Check Digit



W086B00

Do Not Transmit UPC-A Check Digit

Transmit Preamble Character

Preamble characters (Country Code and System Character) can be transmitted as part of a UPC-A barcode. Select one of the following options for transmitting UPC-A preamble to the host device: transmit system character only, transmit system character and country code ("0" for USA), or transmit no preamble.



W036A00

No Preamble



W036A01

** System Character



W036A02

System Character & Country Code



W010F00

Exit Setup



W010F01

** Enter Setup

Add-On Code

A UPC-A barcode can be augmented with a two-digit or five-digit add-on code to form a new one. In the examples below, the part surrounded by blue dotted line is a UPC-A barcode while the part circled by red dotted line is add-on code.



W206B20

Enable 2-Digit Add-On Code



W206B00

** Disable 2-Digit Add-On Code



W406B40

Enable 5-Digit Add-On Code



W406B00

** Disable 5-Digit Add-On Code

Enable 2-Digit Add-On Code/ Enable 5-Digit Add-On Code: The scanner decodes a mix of UPC-A barcodes with and without 2-digit/5-digit add-on codes.

Disable 2-Digit Add-On Code/ Disable 5-Digit Add-On Code: The scanner decodes UPC-A and ignores the add-on code when presented with a UPC-A plus add-on barcode. It can also decode UPC-A barcodes without add-on codes.



W010F00

Exit Setup



W010F01

** Enter Setup

Add-On Code Required

This parameter is only valid when **Enable 2-Digit Add-On Code** and/or **Enable 5-Digit Add-On Code** is selected.



W106B10

UPC-A Add-On Code Required



W106B00

** UPC-A Add-On Code Not Required



W010F00

Exit Setup



W010F01

** Enter Setup

Interleaved 2 of 5

Restore Factory Defaults



WFFD99A

Restore the Factory Defaults of Interleaved 2 of 5

Enable/Disable Interleaved 2 of 5



W016C01

** Enable Interleaved 2 of 5



W016C00

Disable Interleaved 2 of 5



W010F00

Exit Setup



W010F01

** Enter Setup

Check Digit Verification

A check digit is optional for Interleaved 2 of 5 and can be added as the last digit. It is a calculated value used to verify the integrity of the data.

Disable: The scanner transmits Interleaved 2 of 5 barcodes as is.

Do Not Transmit Check Digit After Verification: The scanner checks the integrity of all Interleaved 2 of 5 barcodes to verify that the data complies with the check digit algorithm. Barcodes passing the check will be transmitted except the last digit, whereas those failing it will not be transmitted.

Transmit Check Digit After Verification: The scanner checks the integrity of all Interleaved 2 of 5 barcodes to verify that the data complies with the check digit algorithm. Barcodes passing the check will be transmitted, whereas those failing it will not be transmitted.



W0C6C00

Disable



W0C6C04

** Do Not Transmit Check Digit After Verification



W0C6C0C

Transmit Check Digit After Verification



W010F00

Exit Setup



W010F01

** Enter Setup

Set Length Range for Interleaved 2 of 5

The scanner can be configured to only decode Interleaved 2 of 5 barcodes with lengths that fall between (inclusive) the minimum and maximum lengths.

The supported maximum length is 255 characters. If minimum length is set to be greater than maximum length, the scanner only decodes Interleaved 2 of 5 barcodes with either the minimum or maximum length. If minimum length is same as maximum length, only Interleaved 2 of 5 barcodes with that length are to be decoded.



M000307

Set the Minimum Length



M000306

Set the Maximum Length

Example: Set the scanner to decode Interleaved 2 of 5 barcodes containing between 8 and 12 characters

1. Scan the **Enter Setup** barcode.
2. Scan the **Set the Minimum Length** barcode.
3. Scan the numeric barcode “8”. (See the **Digit Barcodes** section in Appendix)
4. Scan the **Save** barcode. (See the **Save/Cancel Barcodes** section in Appendix)
5. Scan the **Set the Maximum Length** barcode.
6. Scan the numeric barcodes “1” and “2”.
7. Scan the **Save** barcode.
8. Scan the **Exit Setup** barcode.



W010F00

Exit Setup



W010F01

** Enter Setup

ITF-6

ITF-6 is a special kind of Interleaved 2 of 5 with a length of 6 characters and the last character as the check character.

Restore Factory Defaults



WFFD99B

Restore the Factory Defaults of ITF-6

Enable/Disable ITF-6

By default, ITF-6 is decoded as Interleaved 2 of 5.



W036D01

Disable ITF-6



W0B6D02

Enable ITF-6 But Do Not Transmit Check Digit



W0B6D0A

Enable ITF-6 and Transmit Check Digit

Note: It is advised not to enable ITF-6 and Interleaved 2 of 5 at the same time.



W010F00

Exit Setup



W010F01

** Enter Setup

ITF-14

ITF-14 is a special kind of Interleaved 2 of 5 with a length of 14 characters and the last character as the check character.

Restore Factory Defaults



WFFD99C

Restore the Factory Defaults of ITF-14

Enable/Disable ITF-14

By default, ITF-14 is decoded as Interleaved 2 of 5.



W036E01

Disable ITF-14



W0B6E02

Enable ITF-14 But Do Not Transmit Check Digit



W0B6E0A

Enable ITF-14 and Transmit Check Digit

Note: It is advised not to enable ITF-14 and Interleaved 2 of 5 at the same time.



W010F00

Exit Setup



W010F01

** Enter Setup

Deutsche 14

Restore Factory Defaults



WFFD99D

Restore the Factory Defaults of Deutsche 14

Enable/Disable Deutsche 14

By default, Deutsche 14 is decoded as Interleaved 2 of 5.



W036F01

Disable Deutsche 14



W0B6F02

Enable Deutsche 14 But Do Not Transmit Check Digit



W0B6F0A

Enable Deutsche 14 and Transmit Check Digit

Note: It is advised not to enable Deutsche 14 unless necessary, because Deutsche 14, ITF-14 and Interleaved 2 of 5 use the same encoding method and enabling them at the same time can easily cause confusion with each other when decoding.



W010F00

Exit Setup



W010F01

** Enter Setup

Deutsche 12

Restore Factory Defaults



WFFD99E

Restore the Factory Defaults of Deutsche 12

Enable/Disable Deutsche 12

By default, Deutsche 12 is decoded as Interleaved 2 of 5.



W037001

Disable Deutsche 12



W0B7002

Enable Deutsche 12 But Do Not Transmit Check Digit



W0B700A

Enable Deutsche 12 and Transmit Check Digit

Note: It is advised not to enable Deutsche 12 unless necessary, because Deutsche 12, ITF-12 and Interleaved 2 of 5 use the same encoding method and enabling them at the same time can easily cause confusion with each other when decoding.



W010F00

Exit Setup



W010F01

** Enter Setup

Matrix 2 of 5 (European Matrix 2 of 5)

Restore Factory Defaults



WFFD99F

Restore the Factory Defaults of Matrix 2 of 5

Enable/Disable Matrix 2 of 5



W017101

** Enable Matrix 2 of 5



W017100

Disable Matrix 2 of 5



W010F00

Exit Setup



W010F01

** Enter Setup

Check Digit Verification

A check digit is optional for Matrix 2 of 5 and can be added as the last digit. It is a calculated value used to verify the integrity of the data.

Disable: The scanner transmits Matrix 2 of 5 barcodes as is.

Do Not Transmit Check Digit After Verification: The scanner checks the integrity of all Matrix 2 of 5 barcodes to verify that the data complies with the check digit algorithm. Barcodes passing the check will be transmitted except the last digit, whereas those failing it will not be transmitted.

Transmit Check Digit After Verification: The scanner checks the integrity of all Matrix 2 of 5 barcodes to verify that the data complies with the check digit algorithm. Barcodes passing the check will be transmitted, whereas those failing it will not be transmitted.



W0C7100

** Disable



W0C7104

Do Not Transmit Check Digit After Verification



W0C710C

Transmit Check Digit After Verification



W010F00

Exit Setup



W010F01

** Enter Setup

Set Length Range for Matrix 2 of 5

The scanner can be configured to only decode Matrix 2 of 5 barcodes with lengths that fall between (inclusive) the minimum and maximum lengths.

The supported maximum length is 255 characters. If minimum length is set to be greater than maximum length, the scanner only decodes Matrix 2 of 5 barcodes with either the minimum or maximum length. If minimum length is same as maximum length, only Matrix 2 of 5 barcodes with that length are to be decoded.



M000309

Set the Minimum Length



M000308

Set the Maximum Length

Example: Set the scanner to decode Matrix 2 of 5 barcodes containing between 8 and 12 characters

1. Scan the **Enter Setup** barcode.
2. Scan the **Set the Minimum Length** barcode.
3. Scan the numeric barcode “8”. (See the **Digit Barcodes** section in Appendix)
4. Scan the **Save** barcode. (See the **Save/Cancel Barcodes** section in Appendix)
5. Scan the **Set the Maximum Length** barcode.
6. Scan the numeric barcodes “1” and “2”.
7. Scan the **Save** barcode.
8. Scan the **Exit Setup** barcode.



W010F00

Exit Setup



W010F01

** Enter Setup

Industrial 25

Restore Factory Defaults



WFFD9A0

Restore the Factory Defaults of Industrial 25

Enable/Disable Industrial 25



W017201

** Enable Industrial 25



W017200

Disable Industrial 25



W010F00

Exit Setup



W010F01

** Enter Setup

Check Digit Verification

A check digit is optional for Industrial 25 and can be added as the last digit. It is a calculated value used to verify the integrity of the data.

Disable: The scanner transmits Industrial 25 barcodes as is.

Do Not Transmit Check Digit After Verification: The scanner checks the integrity of all Industrial 25 barcodes to verify that the data complies with the check digit algorithm. Barcodes passing the check will be transmitted except the last digit, whereas those failing it will not be transmitted.

Transmit Check Digit After Verification: The scanner checks the integrity of all Industrial 25 barcodes to verify that the data complies with the check digit algorithm. Barcodes passing the check will be transmitted, whereas those failing it will not be transmitted.



W0C7200

** Disable



W0C7204

Do Not Transmit Check Digit After Verification



W0C720C

Transmit Check Digit After Verification



W010F00

Exit Setup



W010F01

** Enter Setup

Set Length Range for Industrial 25

The scanner can be configured to only decode Industrial 25 barcodes with lengths that fall between (inclusive) the minimum and maximum lengths.

The supported maximum length is 255 characters. If minimum length is set to be greater than maximum length, the scanner only decodes Industrial 25 barcodes with either the minimum or maximum length. If minimum length is same as maximum length, only Industrial 25 barcodes with that length are to be decoded.



M00030B

Set the Minimum Length



M00030A

Set the Maximum Length

Example: Set the scanner to decode Industrial 25 barcodes containing between 8 and 12 characters

1. Scan the **Enter Setup** barcode.
2. Scan the **Set the Minimum Length** barcode.
3. Scan the numeric barcode “8”. (See the **Digit Barcodes** section in Appendix)
4. Scan the **Save** barcode. (See the **Save/Cancel Barcodes** section in Appendix)
5. Scan the **Set the Maximum Length** barcode.
6. Scan the numeric barcodes “1” and “2”.
7. Scan the **Save** barcode.
8. Scan the **Exit Setup** barcode.



W010F00

Exit Setup



W010F01

** Enter Setup

Standard 25

Restore Factory Defaults



WFFD9A1

Restore the Factory Defaults of Standard 25

Enable/Disable Standard 25



W017301

** Enable Standard 25



W017300

Disable Standard 25



W010F00

Exit Setup



W010F01

** Enter Setup

Check Digit Verification

A check digit is optional for Standard 25 and can be added as the last digit. It is a calculated value used to verify the integrity of the data.

Disable: The scanner transmits Standard 25 barcodes as is.

Do Not Transmit Check Digit After Verification: The scanner checks the integrity of all Standard 25 barcodes to verify that the data complies with the check digit algorithm. Barcodes passing the check will be transmitted except the last digit, whereas those failing it will not be transmitted.

Transmit Check Digit After Verification: The scanner checks the integrity of all Standard 25 barcodes to verify that the data complies with the check digit algorithm. Barcodes passing the check will be transmitted, whereas those failing it will not be transmitted.



W0C7300

** Disable



W0C7304

Do Not Transmit Check Digit After Verification



W0C730C

Transmit Check Digit After Verification



W010F00

Exit Setup



W010F01

** Enter Setup

Set Length Range for Standard 25

The scanner can be configured to only decode Standard 25 barcodes with lengths that fall between (inclusive) the minimum and maximum lengths.

The supported maximum length is 255 characters. If minimum length is set to be greater than maximum length, the scanner only decodes Standard 25 barcodes with either the minimum or maximum length. If minimum length is same as maximum length, only Standard 25 barcodes with that length are to be decoded.



M00030D

Set the Minimum Length



M00030C

Set the Maximum Length

Example: Set the scanner to decode Standard 25 barcodes containing between 8 and 12 characters

1. Scan the **Enter Setup** barcode.
2. Scan the **Set the Minimum Length** barcode.
3. Scan the numeric barcode “8”. (See the **Digit Barcodes** section in Appendix)
4. Scan the **Save** barcode. (See the **Save/Cancel Barcodes** section in Appendix)
5. Scan the **Set the Maximum Length** barcode.
6. Scan the numeric barcodes “1” and “2”.
7. Scan the **Save** barcode.
8. Scan the **Exit Setup** barcode.



W010F00

Exit Setup



W010F01

** Enter Setup

Code 39

Restore Factory Defaults



WFFD9A2

Restore the Factory Defaults of Code 39

Enable/Disable Code 39



W017401

** Enable Code 39



W017400

Disable Code 39



W010F00

Exit Setup



W010F01

** Enter Setup

Check Digit Verification

A check digit is optional for Code 39 and can be added as the last digit. It is a calculated value used to verify the integrity of the data.

Disable: The scanner transmits Code 39 barcodes as is.

Do Not Transmit Check Digit After Verification: The scanner checks the integrity of all Code 39 barcodes to verify that the data complies with the check digit algorithm. Barcodes passing the check will be transmitted except the last digit, whereas those failing it will not be transmitted.

Transmit Check Digit After Verification: The scanner checks the integrity of all Code 39 barcodes to verify that the data complies with the check digit algorithm. Barcodes passing the check will be transmitted, whereas those failing it will not be transmitted.



W187400

** Disable



W187408

Do Not Transmit Check Digit After Verification



W187418

Transmit Check Digit After Verification



W010F00

Exit Setup



W010F01

** Enter Setup

Transmit Start/Stop Characters

Code 39 uses an asterisk (*) for both the start and the stop characters. You can choose whether or not to transmit the start/stop characters by scanning the appropriate barcode below.



W047404

Transmit Start/Stop Characters



W047400

** Do Not Transmit Start/Stop Characters

Enable/Disable Code 39 Full ASCII

The scanner can be configured to identify all ASCII characters by scanning the appropriate barcode below.



W207420

** Enable Code 39 Full ASCII



W207400

Disable Code 39 Full ASCII



W010F00

Exit Setup



W010F01

** Enter Setup

Set Length Range for Code 39

The scanner can be configured to only decode Code 39 barcodes with lengths that fall between (inclusive) the minimum and maximum lengths.

The supported maximum length is 255 characters. If minimum length is set to be greater than maximum length, the scanner only decodes Code 39 barcodes with either the minimum or maximum length. If minimum length is same as maximum length, only Code 39 barcodes with that length are to be decoded.



M00030F

Set the Minimum Length



M00030E

Set the Maximum Length

Example: Set the scanner to decode Code 39 barcodes containing between 8 and 12 characters.

1. Scan the **Enter Setup** barcode.
2. Scan the **Set the Minimum Length** barcode.
3. Scan the numeric barcode “8”. (See the **Digit Barcodes** section in Appendix)
4. Scan the **Save** barcode. (See the **Save/Cancel Barcodes** section in Appendix)
5. Scan the **Set the Maximum Length** barcode.
6. Scan the numeric barcode “1”.
7. Scan the numeric barcode “2”.
8. Scan the **Save** barcode.
9. Scan the **Exit Setup** barcode.



W010F00

Exit Setup



W010F01

** Enter Setup

Codabar

Restore Factory Defaults



WFFD9A3

Restore the Factory Defaults of Codabar

Enable/Disable Codabar



W017501

** Enable Codabar



W017500

Disable Codabar



W010F00

Exit Setup



W010F01

** Enter Setup

Check Digit Verification

A check digit is optional for Codabar and can be added as the last digit. It is a calculated value used to verify the integrity of the data.

Disable: The scanner transmits Codabar barcodes as is.

Do Not Transmit Check Digit After Verification: The scanner checks the integrity of all Codabar barcodes to verify that the data complies with the check digit algorithm. Barcodes passing the check will be transmitted except the last digit, whereas those failing it will not be transmitted.

Transmit Check Digit After Verification: The scanner checks the integrity of all Codabar barcodes to verify that the data complies with the check digit algorithm. Barcodes passing the check will be transmitted, whereas those failing it will not be transmitted.



W607500

** Disable



W607520

Do Not Transmit Check Digit After Verification



W607560

Transmit Check Digit After Verification



W010F00

Exit Setup



W010F01

** Enter Setup

Start/Stop Characters



W047504

** Transmit Start/Stop Characters



W047500

Do Not Transmit Start/Stop Characters



W187500

** ABCD/ABCD as the Start/Stop Character



W187508

ABCD/TN*E as the Start/Stop Character



W187510

abcd/abcd as the Start/Stop Character



W187518

abcd/tn*e as the Start/Stop Character



W010F00

Exit Setup



W010F01

** Enter Setup

Set Length Range for Codabar

The scanner can be configured to only decode Codabar barcodes with lengths that fall between (inclusive) the minimum and maximum lengths.

The supported maximum length is 255 characters. If minimum length is set to be greater than maximum length, the scanner only decodes Codabar barcodes with either the minimum or maximum length. If minimum length is same as maximum length, only Codabar barcodes with that length are to be decoded.



M000311

Set the Minimum Length



M000310

Set the Maximum Length

Example: Set the scanner to decode Codabar barcodes containing between 8 and 12 characters.

1. Scan the **Enter Setup** barcode.
2. Scan the **Set the Minimum Length** barcode.
3. Scan the numeric barcode “8”. (See the **Digit Barcodes** section in Appendix)
4. Scan the **Save** barcode. (See the **Save/Cancel Barcodes** section in Appendix)
5. Scan the **Set the Maximum Length** barcode.
6. Scan the numeric barcode “1”.
7. Scan the numeric barcode “2”.
8. Scan the **Save** barcode.
9. Scan the **Exit Setup** barcode.



W010F00

Exit Setup



W010F01

** Enter Setup

Code 93

Restore Factory Defaults



WFFD9A4

Restore the Factory Defaults of Code 93

Enable/Disable Code 93



W017601

** Enable Code 93



W017600

Disable Code 93



W010F00

Exit Setup



W010F01

** Enter Setup

Check Digit Verification

Check digits are optional for Code 93 and can be added as the last two digits, which are calculated values used to verify the integrity of the data.

Disable: The scanner transmits Code 93 barcodes as is.

Do Not Transmit Check Digit After Verification: The scanner checks the integrity of all Code 93 barcodes to verify that the data complies with the check digit algorithm. Barcodes passing the checks will be transmitted except the last two digits, whereas those failing them will not be transmitted.

Transmit Check Digit After Verification: The scanner checks the integrity of all Code 93 barcodes to verify that the data complies with the check digit algorithm. Barcodes passing the checks will be transmitted, whereas those failing them will not be transmitted.



W0C7600

Disable



W0C7604

** Do Not Transmit Check Digit After Verification



W0C760C

Transmit Check Digit After Verification



W010F00

Exit Setup



W010F01

** Enter Setup

Set Length Range for Code 93

The scanner can be configured to only decode Code 93 barcodes with lengths that fall between (inclusive) the minimum and maximum lengths.

The supported maximum length is 255 characters. If minimum length is set to be greater than maximum length, the scanner only decodes Code 93 barcodes with either the minimum or maximum length. If minimum length is same as maximum length, only Code 93 barcodes with that length are to be decoded.



M000313

Set the Minimum Length



M000312

Set the Maximum Length

Example: Set the scanner to decode Code 93 barcodes containing between 8 and 12 characters.

1. Scan the **Enter Setup** barcode.
2. Scan the **Set the Minimum Length** barcode.
3. Scan the numeric barcode “8”. (See the **Digit Barcodes** section in Appendix)
4. Scan the **Save** barcode. (See the **Save/Cancel Barcodes** section in Appendix)
5. Scan the **Set the Maximum Length** barcode.
6. Scan the numeric barcode “1”.
7. Scan the numeric barcode “2”.
8. Scan the **Save** barcode.
9. Scan the **Exit Setup** barcode.



W010F00

Exit Setup



W010F01

** Enter Setup

Code 11

Restore Factory Defaults



WFFD9A5

Restore the Factory Defaults of Code 11

Enable/Disable Code 11



W017701

Enable Code 11



W017700

** Disable Code 11



W010F00

Exit Setup



W010F01

** Enter Setup

Check Digit Verification

Check digits are optional for Code 11 and can be added as the last one or two digits, which are calculated values used to verify the integrity of the data.

If the **Disable** option is enabled, the scanner transmits Code 11 barcodes as is.



W1C7700

Disable



W1C7704

** One Check Digit, MOD11



W1C7708

Two Check Digits, MOD11/MOD11



W1C770C

Two Check Digits, MOD11/MOD9



W1C7710

One Check Digit, MOD11 (Len <= 11)
Two Check Digits, MOD11/MOD11 (Len > 11)



W1C7714

One Check Digit, MOD11 (Len <= 11)
Two Check Digits, MOD11/MOD9 (Len > 11)



W207720

Transmit Check Digit



W207700

** Do Not Transmit Check Digit



W010F00

Exit Setup



W010F01

** Enter Setup

Set Length Range for Code 11

The scanner can be configured to only decode Code 11 barcodes with lengths that fall between (inclusive) the minimum and maximum lengths.

The supported maximum length is 255 characters. If minimum length is set to be greater than maximum length, the scanner only decodes Code 11 barcodes with either the minimum or maximum length. If minimum length is same as maximum length, only Code 11 barcodes with that length are to be decoded.



M000315

Set the Minimum Length



M000314

Set the Maximum Length

Example: Set the scanner to decode Code 11 barcodes containing between 8 and 12 characters.

1. Scan the **Enter Setup** barcode.
2. Scan the **Set the Minimum Length** barcode.
3. Scan the numeric barcode “8”. (See the **Digit Barcodes** section in Appendix)
4. Scan the **Save** barcode. (See the **Save/Cancel Barcodes** section in Appendix)
5. Scan the **Set the Maximum Length** barcode.
6. Scan the numeric barcode “1”.
7. Scan the numeric barcode “2”.
8. Scan the **Save** barcode.
9. Scan the **Exit Setup** barcode.



W010F00

Exit Setup



W010F01

** Enter Setup

Plessey

Restore Factory Defaults



WFFD9A6

Restore the Factory Defaults of Plessey

Enable/Disable Plessey



W017801

Enable Plessey



W017800

** Disable Plessey



W010F00

Exit Setup



W010F01

** Enter Setup

Check Digit Verification

Check digits are optional for Plessey and can be added as the last one or two digits, which are calculated values used to verify the integrity of the data.

Disable: The scanner transmits Plessey barcodes as is.

Do Not Transmit Check Digit After Verification: The scanner checks the integrity of all Plessey barcodes to verify that the data complies with the check digit algorithm. Barcodes passing the checks will be transmitted except the last two digits, whereas those failing them will not be transmitted.

Transmit Check Digit After Verification: The scanner checks the integrity of all Plessey barcodes to verify that the data complies with the check digit algorithm. Barcodes passing the checks will be transmitted, whereas those failing them will not be transmitted.



W0C7800

Disable



W0C7804

** Do Not Transmit Check Digit After Verification



W0C780C

Transmit Check Digit After Verification



W010F00

Exit Setup



W010F01

** Enter Setup

Set Length Range for Plessey

The scanner can be configured to only decode Plessey barcodes with lengths that fall between (inclusive) the minimum and maximum lengths.

The supported maximum length is 255 characters. If minimum length is set to be greater than maximum length, the scanner only decodes Plessey barcodes with either the minimum or maximum length. If minimum length is same as maximum length, only Plessey barcodes with that length are to be decoded.



M000317

Set the Minimum Length



M000316

Set the Maximum Length

Example: Set the scanner to decode Plessey barcodes containing between 8 and 12 characters.

1. Scan the **Enter Setup** barcode.
2. Scan the **Set the Minimum Length** barcode.
3. Scan the numeric barcode “8”. (See the **Digit Barcodes** section in Appendix)
4. Scan the **Save** barcode. (See the **Save/Cancel Barcodes** section in Appendix)
5. Scan the **Set the Maximum Length** barcode.
6. Scan the numeric barcode “1”.
7. Scan the numeric barcode “2”.
8. Scan the **Save** barcode.
9. Scan the **Exit Setup** barcode.



W010F00

Exit Setup



W010F01

** Enter Setup

MSI-Plessey

Restore Factory Defaults



WFFD9A7

Restore the Factory Defaults of MSI-Plessey

Enable/Disable MSI-Plessey



W017901

Enable MSI-Plessey



W017900

** Disable MSI-Plessey



W010F00

Exit Setup



W010F01

** Enter Setup

Check Digit Verification

Check digits are optional for MSI-Plessey and can be added as the last one or two digits, which are calculated values used to verify the integrity of the data.

If the **Disable** option is enabled, the scanner transmits MSI-Plessey barcodes as is.



W0C7900

Disable



W0C7904

** One Check Digit, MOD10



W0C7908

Two Check Digits, MOD10/MOD10



W0C790C

Two Check Digits, MOD10/MOD11



W107910

Transmit Check Digit



W107900

** Do Not Transmit Check Digit



W010F00

Exit Setup



W010F01

** Enter Setup

Set Length Range for MSI-Plessey

The scanner can be configured to only decode MSI-Plessey barcodes with lengths that fall between (inclusive) the minimum and maximum lengths.

The supported maximum length is 255 characters. If minimum length is set to be greater than maximum length, the scanner only decodes MSI-Plessey barcodes with either the minimum or maximum length. If minimum length is same as maximum length, only MSI-Plessey barcodes with that length are to be decoded.



M000319

Set the Minimum Length



M000318

Set the Maximum Length

Example: Set the scanner to decode MSI-Plessey barcodes containing between 8 and 12 characters.

1. Scan the **Enter Setup** barcode.
2. Scan the **Set the Minimum Length** barcode.
3. Scan the numeric barcode “8”. (See the **Digit Barcodes** section in Appendix)
4. Scan the **Save** barcode. (See the **Save/Cancel Barcodes** section in Appendix)
5. Scan the **Set the Maximum Length** barcode.
6. Scan the numeric barcode “1”.
7. Scan the numeric barcode “2”.
8. Scan the **Save** barcode.
9. Scan the **Exit Setup** barcode.



W010F00

Exit Setup



W010F01

** Enter Setup

RSS-14

Restore Factory Defaults



WFFD9A8

Restore the Factory Defaults of RSS-14

Enable/Disable RSS-14



W017A01

** Enable RSS-14



W017A00

Disable RSS-14

Transmit Application Identifier "01"



W047A04

** Transmit Application Identifier "01"



W047A00

Do Not Transmit Application Identifier "01"



W010F00

Exit Setup



W010F01

** Enter Setup

RSS-Limited

Restore Factory Defaults



WFFD9A9

Restore the Factory Defaults of RSS-Limited

Enable/Disable RSS-Limited



W017B01

** Enable RSS-Limited



W017B00

Disable RSS-Limited

Transmit Application Identifier "01"



W047B04

** Transmit Application Identifier "01"



W047B00

Do Not Transmit Application Identifier "01"



W010F00

Exit Setup



W010F01

** Enter Setup

RSS-Expand

Restore Factory Defaults



WFFD9AA

Restore the Factory Defaults of RSS-Expand

Enable/Disable RSS-Expand



W017C01

** Enable RSS-Expand



W017C00

Disable RSS-Expand



W010F00

Exit Setup

Appendix

Factory Defaults Table

Parameter		Factory Default	Remark
System Settings			
Barcode Programming		Enabled	
Programming Barcode Data		Do not send	
Scan Mode		Manual Mode	
Manual Mode	Decode Session Timeout	15s	1-255s; 0: infinite.
Continuous Mode	Decode Session Timeout	15s	1-255s; 0: infinite.
	Timeout between Decodes	1.0s	0.0-25.5s
	Reread Same Barcode	With no delay	To disable rereads of same barcode, enable the Reread Same Barcode with a Delay and set the delay to 0.
Sense Mode	Decode Session Timeout	15s	1-255s; 0: infinite.
	Image Stabilization Timeout	0.4s	0.0-25.5s
	Reread Same Barcode	With no delay	To disable rereads of same barcode, enable the Reread Same Barcode with a Delay and set the delay to 0.
	Sensitivity	Medium	
Command Trigger Mode	Decode Session Timeout	15s	1-255s; 0: infinite.
Security Level		0	
Good Read Beep		Enabled	
Good Read Beep Frequency		Medium	
Good Read Beep Duration		80ms	
Decode Result Notification		Disabled	
Silent Mode		Disabled	Temporary setting
Illumination		On When Scanning	Temporary setting

Parameter		Factory Default	Remark
Communication Interfaces			
TTL-232 Interface	Baud Rate	9600	
	Parity Check	None	
	Number of Data Bits	8	
	Number of Stop Bits	1	
	Flow Control	None	
USB Interface		USB HID-KBW	Other options: DataPipe, USB COM Port Emulation, HID-POS
USB HID-KBW	Input Mode	Standard Keyboard	
	USB Country Keyboard Type	U.S.	
	Inter-Keystroke Delay	No delay	
	Convert Case	No Conversion	
	Emulate Numeric Keypad	Disabled	
Data Formatting			
Prefix Sequence		Code ID+Custom+AIM ID	
AIM ID Prefix		Disabled	
Code ID Prefix		Disabled	1 or 2 English letters
Custom Prefix		Disabled	1 to 5 characters
Custom Suffix		Disabled	1 to 5 characters
Terminating Character Suffix		Enabled, 0x0D,0x0A	0x0D,0x0A: CRLF

Parameter	Factory Default	Remark
Code 128		
Code 128	Enabled	
Minimum Length	1	No less than 1 (including check digit)
Maximum Length	80	
UCC/EAN-128 (GS1-128)		
UCC/EAN-128	Enabled	
Minimum Length	1	No less than 1 (including check digit)
Maximum Length	80	
AIM 128		
AIM 128	Disabled	
Minimum Length	1	No less than 1 (including check digit)
Maximum Length	80	
EAN-8		
EAN-8	Enabled	
Check Digit	Transmit	
2-Digit Add-On Code	Disabled	
5-Digit Add-On Code	Disabled	
Add-On Code	Not required	
Extend to EAN-13	Disabled	
EAN-13		
EAN-13	Enabled	
Check Digit	Transmit	
2-Digit Add-On Code	Disabled	
5-Digit Add-On Code	Disabled	
Add-On Code	Not required	
ISSN		
ISSN	Disabled	
ISBN		
ISBN	Disabled	
ISBN Format	ISBN-13	

Parameter	Factory Default	Remark
UPC-E		
UPC-E	Enabled	
Check Digit	Transmit	
2-Digit Add-On Code	Disabled	
5-Digit Add-On Code	Disabled	
Add-On Code	Not required	
Extend to UPC-A	Disabled	
System Character	Transmit	
UPC-A		
UPC-A	Enabled	
Check Digit	Transmit	
2-Digit Add-On Code	Disabled	
5-Digit Add-On Code	Disabled	
Add-On Code	Not required	
Transmit Preamble Character	System character	
Interleaved 2 of 5		
Interleaved 2 of 5	Enabled	
Check Digit Verification	Enabled	
Check Digit	Do not transmit	
Minimum Length	6	No less than 3 (including check digit)
Maximum Length	100	
ITF-6		
ITF-6	Decode as I25	
Check Digit	Transmit	
ITF-14		
ITF-14	Decode as I25	
Check Digit	Transmit	
Deutsche 14		
Deutsche 14	Decode as I25	
Check Digit	Transmit	
Deutsche 12		
Deutsche 12	Decode as I25	
Check Digit	Transmit	

Parameter	Factory Default	Remark
Matrix 2 of 5		
Matrix 2 of 5	Enabled	
Check Digit Verification	Disabled	
Check Digit	Do not transmit	
Minimum Length	6	No less than 2 (including check digit)
Maximum Length	80	
Industrial 25		
Industrial 25	Enabled	
Check Digit Verification	Disabled	
Check Digit	Do not transmit	
Minimum Length	6	No less than 2 (including check digit)
Maximum Length	80	
Standard 25		
Standard 25	Enabled	
Check Digit Verification	Disabled	
Check Digit	Do not transmit	
Minimum Length	6	No less than 2 (including check digit)
Maximum Length	80	
Code 39		
Code 39	Enabled	
Check Digit Verification	Disabled	
Check Digit	Do not transmit	
Start/Stop Characters	Do not transmit	
Code 39 Full ASCII	Enabled	
Minimum Length	4	No less than 2 (including check digit)
Maximum Length	50	

Parameter	Factory Default	Remark
Codabar		
Codabar	Enabled	
Check Digit Verification	Disabled	
Check Digit	Do not transmit	
Start/Stop Characters	Transmit	
Start/Stop Character Format	ABCD/ABCD	
Minimum Length	4	No less than 1 (including check digit)
Maximum Length	60	
Code 93		
Code 93	Enabled	
Check Digit Verification	Enabled	
Check Digit	Do not transmit	
Minimum Length	2	No less than 1 (including check digit)
Maximum Length	80	
Code 11		
Code 11	Disabled	
Check Digit Verification	One check digit, MOD11	
Check Digit	Do not transmit	
Minimum Length	4	No less than 2 (including check digit)
Maximum Length	80	
Plessey		
Plessey	Disabled	
Check Digit Verification	Enabled	
Check Digit	Do not transmit	
Minimum Length	4	No less than 3 (including check digit)
Maximum Length	60	

Parameter	Factory Default	Remark
<i>MSI-Plessey</i>		
MSI-Plessey	Disabled	
Check Digit Verification	One check digit, MOD10	
Check Digit	Do not transmit	
Minimum Length	4	No less than 2 (including check digit)
Maximum Length	60	
<i>RSS-14</i>		
RSS-14	Enabled	
AI (Application Identifier)	Transmit	
<i>RSS-Limited</i>		
RSS-Limited	Enabled	
AI (Application Identifier)	Transmit	
<i>RSS-Expand</i>		
RSS-Expand	Enabled	

AIM ID Table

Symbology	AIM ID	Remark
Code 128	JC0	Standard Code 128
UCC/EAN 128 (GS1-128)	JC1	FNC1 is the character right after the start character
AIM 128	JC2	FNC1 is the 2nd character after the start character
EAN-8	JE4	Standard EAN-8
	JE4....JE1...	EAN-8 + 2-Digit Add-On Code
	JE4....JE2...	EAN-8 + 5-Digit Add-On Code
EAN-13	JE0	Standard EAN-13
	JE3	EAN-13 + 2/5-Digit Add-On Code
ISSN	JX5	
ISBN	JX4	
UPC-E	JE0	Standard UPC-E
	JE3	UPC-E + 2/5-Digit Add-On Code
UPC-A	JE0	Standard UPC-A
	JE3	UPC-A + 2/5-Digit Add-On Code
Interleaved 2 of 5	Jl0	No check digit verification
	Jl1	Transmit check digit after verification
	Jl3	Do not transmit check digit after verification
ITF-6	Jl1	Transmit check digit
	Jl3	Do not transmit check digit
ITF-14	Jl1	Transmit check digit
	Jl3	Do not transmit check digit
Deutsche 14 Deutsche 12	JX0	
Matrix 2 of 5	JX1	No check digit verification
	JX2	Transmit check digit after verification
	JX3	Do not transmit check digit after verification
Industrial 25	JS0	Not specified
Standard 25	JR0	No check digit verification
	JR8	One check digit, MOD 7; do not transmit check digit
	JR9	One check digit, MOD 7; transmit check digit

Symbology	AIM ID	Remark
Code 39	JA0	Transmit barcodes as is; Full ASCII disabled; no check digit verification
	JA1	One check digit, MOD 43; transmit check digit
	JA3	One check digit, MOD 43; do not transmit check digit
	JA4	Full ASCII enabled; no check digit verification
	JA5	Full ASCII enabled; MOD43; transmit check digit
	JA7	Full ASCII enabled; MOD43; do not transmit check digit
Codabar	JF0	Standard Codabar
	JF1	ABC Codabar
	JF2	Transmit check digit after verification
	JF4	Do not transmit check digit after verification
Code 93	JG0	Not specified
Code 11	JH0	One check digit, MOD11; transmit check digit
	JH1	Two check digits, MOD11/MOD11; transmit check digit
	JH3	Do not transmit check digit after verification
	JH8	Two check digits, MOD11/MOD9; transmit check digit
	JH9	No check digit verification
Plessey	JP0	Not specified
MSI Plessey	JM0	One check digit, MOD10; transmit check digit
	JM1	One check digit, MOD10; do not transmit check digit
	JM7	Two check digits, MOD10 /MOD11; do not transmit check digit
	JM8	Two check digits, MOD10 /MOD11; transmit check digit
	JM9	No check digit verification
RSS-14/RSS-Limited RSS-Expand	Je0	Standard
	Je1	User-defined
	Je2	User-defined
	Je3	User-defined

Reference: ISO/IEC 15424:2008 Information technology – Automatic identification and data capture techniques – Data Carrier Identifiers (including Symbology Identifiers)

Code ID Table

Symbology	Code ID
Code 128	j
UCC/EAN-128	u
AIM 128	f
SETTING 128	t
EAN-8	g
EAN-13	d
ISSN	n
ISBN	B
UPC-E	h
UPC-A	c
Interleaved 2 of 5	e
ITF-6	r
ITF-14	q
Deutsche 14	w
Deutsche 12	l
Matrix 2 of 5(European Matrix 2 of 5)	v
Industrial 25	i
Standard 25	s
Code 39	b
Codabar	a
Code 93	y
Code 11	z
Plessey	p
MSI-Plessey	m
RSS-14	D
RSS-Limited	C
RSS-Expand	R

ASCII Table

Hex	Dec	Char
00	0	NUL (Null char.)
01	1	SOH (Start of Header)
02	2	STX (Start of Text)
03	3	ETX (End of Text)
04	4	EOT (End of Transmission)
05	5	ENQ (Enquiry)
06	6	ACK (Acknowledgment)
07	7	BEL (Bell)
08	8	BS (Backspace)
09	9	HT (Horizontal Tab)
0a	10	LF (Line Feed)
0b	11	VT (Vertical Tab)
0c	12	FF (Form Feed)
0d	13	CR (Carriage Return)
0e	14	SO (Shift Out)
0f	15	SI (Shift In)
10	16	DLE (Data Link Escape)
11	17	DC1 (XON) (Device Control 1)
12	18	DC2 (Device Control 2)
13	19	DC3 (XOFF) (Device Control 3)
14	20	DC4 (Device Control 4)
15	21	NAK (Negative Acknowledgment)
16	22	SYN (Synchronous Idle)
17	23	ETB (End of Trans. Block)
18	24	CAN (Cancel)
19	25	EM (End of Medium)
1a	26	SUB (Substitute)
1b	27	ESC (Escape)
1c	28	FS (File Separator)
1d	29	GS (Group Separator)

Hex	Dec	Char
1e	30	RS (Request to Send)
1f	31	US (Unit Separator)
20	32	SP (Space)
21	33	! (Exclamation Mark)
22	34	" (Double Quote)
23	35	# (Number Sign)
24	36	\$ (Dollar Sign)
25	37	% (Percent)
26	38	& (Ampersand)
27	39	` (Single Quote)
28	40	((Right / Closing Parenthesis)
29	41) (Right / Closing Parenthesis)
2a	42	* (Asterisk)
2b	43	+ (Plus)
2c	44	, (Comma)
2d	45	- (Minus / Dash)
2e	46	. (Dot)
2f	47	/ (Forward Slash)
30	48	0
31	49	1
32	50	2
33	51	3
34	52	4
35	53	5
36	54	6
37	55	7
38	56	8
39	57	9
3a	58	: (Colon)
3b	59	; (Semi-colon)
3c	60	< (Less Than)
3d	61	= (Equal Sign)

Hex	Dec	Char
3e	62	> (Greater Than)
3f	63	? (Question Mark)
40	64	@ (AT Symbol)
41	65	A
42	66	B
43	67	C
44	68	D
45	69	E
46	70	F
47	71	G
48	72	H
49	73	I
4a	74	J
4b	75	K
4c	76	L
4d	77	M
4e	78	N
4f	79	O
50	80	P
51	81	Q
52	82	R
53	83	S
54	84	T
55	85	U
56	86	V
57	87	W
58	88	X
59	89	Y
5a	90	Z
5b	91	[(Left / Opening Bracket)
5c	92	\ (Back Slash)
5d	93] (Right / Closing Bracket)

Hex	Dec	Char
5e	94	^ (Caret / Circumflex)
5f	95	_ (Underscore)
60	96	' (Grave Accent)
61	97	A
62	98	B
63	99	C
64	100	d
65	101	e
66	102	f
67	103	g
68	104	h
69	105	i
6a	106	j
6b	107	k
6c	108	l
6d	109	m
6e	110	n
6f	111	o
70	112	p
71	113	q
72	114	r
73	115	s
74	116	t
75	117	u
76	118	v
77	119	w
78	120	x
79	121	y
7a	122	z
7b	123	{ (Left/ Opening Brace)
7c	124	(Vertical Bar)
7d	125	} (Right/Closing Brace)
7e	126	~ (Tilde)
7f	127	DEL (Delete)

Digit Barcodes

0 ~ 5

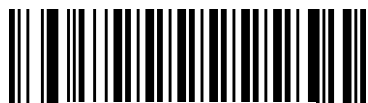

D 0 0 0 0 0 0

0



D 0 0 0 0 0 1

1



D 0 0 0 0 0 2

2



D 0 0 0 0 0 3

3



D 0 0 0 0 0 4

4



D 0 0 0 0 0 5

5

6~ 9



D000006

6



D000007

7



D000008

8



D000009

9

A ~ F



D00000A

A



D00000B

B



D00000C

C



D00000D

D



D00000E

E



D00000F

F

Save/Cancel Barcodes

After reading numeric barcode(s), you need to scan the **Save** barcode to save the data. If you scan the wrong digit(s), you can either scan the **Cancel the Last Digit** barcode and then the correct digit, or scan the **Cancel All Digits** barcode and then the digits you want.

For instance, after reading the **Decode Session Timeout** barcode and numeric barcodes “1”, “2” and “3”, you scan:

Cancel the Last Digit: The last digit “3” will be removed.

Cancel All Digits: All digits “123” will be removed.



D 0 0 0 0 1 2

Save



D 0 0 0 0 1 0

Cancel the Last Digit



D 0 0 0 0 1 1

Cancel All Digits

F1~F12

When the USB HID-KBW feature is enabled, scanning one of the following barcodes will send the corresponding function key.

F1~F6



F000000

F1



F000001

F2



F000002

F3



F000003

F4



F000004

F5



F000005

F6

F7~F12



F000006

F7



F000007

F8



F000008

F9



F000009

F10



F00000A

F11



F00000B

F12